



Skills Funding
Agency

Provider Support Manual for 2016 to 2017

Version 3

Title	Provider Support Manual for 2016 to 2017
Purpose	To provide additional guidance and support for the technical specification of the data collection requirements and file format of the ILR. To support the intended audience to be able to meet the requirements for ILR data returns in 2016 to 2017.
Intended audience	This document is aimed at those responsible for collection of ILR data from learners; making data returns; data specification implementation; and MI system design (including MI managers, commercial software suppliers and own software writers)
Version	3

Document history:

- Version 1** Published May 2016. Changes from the 2015 to 2016 manual are highlighted in yellow. Please note that the index and order of content have been revised since 2015 to 2016. For 2016 to 2017, this document also contains guidance about apprenticeship standards, which was published as a separate document in 2015 to 2016.
- Version 2** Published September 2016. Changes from version 1 are highlighted in green
- Version 3** Published December 2016. Changes from version 2 are highlighted in blue

Contents

Section 1	: Introducing the ILR	7
1.1	Related information and documentation	7
1.2	Feconnect	8
Section 2	: What is the ILR data used for?	9
2.1	The requirement for data	9
Section 3	: Coverage of the ILR	10
3.1	16-19 EFA funding	10
3.2	Adult skills funding	10
3.3	Former Community Learning	11
3.4	European Social Fund (ESF)	12
3.5	Traineeships	12
3.6	Learning that is not funded by the SFA or EFA	12
3.7	Subcontracted provision	14
3.8	Definition of provider type	15
Section 4	: How to collect ILR data	16
Section 5	: Data management principles and ILR completion	17
Section 6	: Sending data to the Skills Funding Agency	19
6.1	File compression	19
6.2	ILR file transmissions	19
6.3	The impact of incomplete information	20
6.4	The Funding Information System (FIS)	20
6.5	Combining ILR files (amalgamation)	20
6.6	Data validation	21
6.7	Earnings adjustment statement (EAS)	23
Section 7	: Returning Data in 2016 to 2017	24
7.1	What to return	24
7.2	Completing the final return for 2016 to 2017	25
7.3	When to return ILR data	25
7.3.1	The ILR timetable for 2016 to 2017	26
Section 8	: Data migration for continuing learners	27
8.1	Migrating data from 2015 to 2016	27
8.2	Migrating employment status records	27
8.3	Coding continuing learners recorded with the WPL indicator	28
8.4	Coding continuing learners on apprenticeship standard programmes	28
8.5	Migration requirements for ESF funded learning and traineeship programmes	28
8.6	Migration requirements for closed aims	29
Section 9	: Completing the ILR	30

9.1	Introduction to the data model	30
9.2	Learner details: completing the Learner entity	31
9.2.1	Learner reference numbers.....	31
9.2.2	Planned learning hours	32
9.3	Recording learner contact details	33
9.3.1	Postcode prior to enrolment	34
9.4	Recording learner contact preference	34
9.5	Recording learner learning difficulties, disabilities (LLDD) and health problems	34
9.6	Recording Learner Funding and Monitoring	35
9.7	Recording employment status	36
9.7.1	Updating employment status.....	37
9.7.2	Learner eligibility	37
9.7.3	Collecting employment status data	38
9.8	Recording learning aims: the Learning Delivery entity.....	41
9.8.1	Recording programme aims.....	41
9.8.2	Recording non-regulated provision	42
9.8.3	Searching for learning aims	43
9.8.4	Recording proxy learning aims	43
9.8.5	Funding adjustment for prior learning and Other funding adjustment	44
9.8.6	Subcontracted or partner UKPRN.....	44
9.8.7	Additional delivery hours	45
9.9	Recording Learning Delivery Funding and Monitoring	46
9.9.1	Recording Source of funding.....	49
9.10	Recording Work Placements	52
9.11	Recording Higher Education (HE) data	53
9.11.1	Recording Learner HE Financial Support.....	54
Section 10	: Recording Learner Destination and Progression	55
10.1	When to collect and return destination and progression data	55
10.2	Updating destination and progression records	56
Section 11	: Recording learner changes	58
11.1	Correcting errors.....	58
11.2	Correcting data errors after 2015 to 2016 hard close	58
11.3	Changes to Learner details	59
11.4	Changes to the Start and Planned End Dates.....	59
11.5	Changes to the learning aim.....	59
11.6	Changes to learning aims within the funding qualifying period	60
11.7	A learner is absent or withdraws	60
11.8	Recording breaks in learning, transfers, and restarts	60

11.8.1	Recording agreed breaks in learning.....	61
11.8.2	Learner transfers	62
11.8.3	Recording restarts (without an agreed break in learning)	65
11.9	Recording learning outcomes	65
11.10	How to delete records.....	66
Section 12 : Recording apprenticeship programmes		67
12.1	Guidance for all apprenticeship programmes	67
12.1.1	Recording employment status for apprenticeships	67
12.1.2	Creating programme aims and component aims.....	68
12.1.3	Eligibility for enhanced apprenticeship funding	69
12.1.4	Apprenticeship training agencies (ATAs)	70
12.2	Additional guidance for apprenticeship frameworks	71
12.2.1	Apprenticeship framework eligibility for enhanced apprenticeship funding	71
12.2.2	Recording framework achievements	71
12.2.3	Recording transfers for apprenticeship frameworks	72
12.3	Additional guidance for apprenticeship standards	73
12.3.1	Recording employment status and identifying small employers	73
12.3.2	Recording apprenticeship standard learning aims.....	73
12.3.3	Recording financial data for apprenticeship standards.....	74
12.3.4	Recording eligibility for employer incentives	78
12.3.5	Recording learner changes for apprenticeship standards.....	78
12.4	Recording higher and degree apprenticeships	82
12.5	Requirements for Higher Education Institutions (HEIs)	82
Section 13 : Recording traineeships in the ILR		84
13.1	Traineeships for 16 to 18 year olds	84
13.2	Traineeships for 19 to 24 year olds	84
13.3	Work experience.....	85
13.4	Work preparation	86
13.5	Traineeships that spread across more than one teaching year.....	86
13.6	Recording completion, achievement and retention	86
13.7	Recording early leavers and transfers.....	87
13.8	Recording destination and progression information	87
Section 14 : EFA study programmes		92
14.1	Planned hours fields.....	92
14.2	GCSE qualification grades	93
14.3	GCSE maths and English condition of funding.....	94
14.4	Recording a core aim	94
14.5	Recording High Needs Students	95

14.5.1	Additional guidance for special post-16 institutions	95
14.6	Recording work experience	96
14.7	Early leavers and transfers.....	100
Section 15	: Guidance on ESF funded learning aims.....	101
15.1	Recording ESF data in the ILR	101
15.1.1	Returning ESF data and destination data	102
15.2	ESF validation and eligibility checks	103
15.3	Supplementary data collection	103
15.4	Amending submitted data	103
15.5	Match Funding.....	103
Section 16	: Recording A and AS levels	104
Section 17	: Recording household situation	108
Section 18	: Field collection requirements tables.....	111
18.1	EFA funded learning.....	111
18.2	Adult Skills funded learning	112
18.3	ESF funded learning.....	113
18.4	Community Learning funded learning	114
18.5	Advanced Learner Loans funded learning	115
18.6	Non-funded learning.....	116
18.7	Field collection requirements by programme	117
18.7.1	Apprenticeship framework programmes	117
18.7.2	Apprenticeship standard programmes.....	120
18.7.3	Traineeship programmes.....	123

Section 1: Introducing the ILR

1. The Individualised Learner Record (ILR) is used by the Skills Funding Agency (SFA) to collect data about learners and the learning undertaken by them from learning providers in the Further Education (FE) and Skills sector. The data collected is used by organisations in the FE and Skills sector for a range of purposes; these are described in Section 2: What is the ILR data used for?
2. The FE and Skills sector includes Further Education Colleges, former External Institutions, Sixth Form Colleges, Training Organisations, Local Authorities, Academies, and Voluntary and Community Organisations. The ILR Specification defines what data is collected for each teaching year from 1 August – 31 July.
3. ILR returns are required from providers who receive funding directly from the SFA or the Education Funding Agency (EFA).
4. This manual contains advice and guidance for providers on how to make ILR returns during the 2016 to 2017 teaching year. In this document, references to 'apprenticeship' apply to all apprenticeship programmes unless otherwise stated. For guidance specific to apprenticeships that start on or after 1 May 2017, refer to the [Guidance for returning apprenticeships on the ILR from 1 May 2017](#).

1.1 Related information and documentation

5. The *Specification of the Individualised Learner Record for 2016 to 2017*, referred to in this manual as *the ILR Specification for 2016 to 2017*, and related documents listed below can be found at <https://www.gov.uk/government/publications/ilr-specification-validation-rules-and-appendices-2016-to-2017>

Document	Description
ILR Specification for 2016 to 2017	Specification of the Individualised Learner Record for 2016 to 2017
Validation rules	A spreadsheet of validation rules and accompanying guidance
Learning delivery monitoring codes/Special project and pilot codes	Learning delivery monitoring (LDM) and Special projects and pilots (SPP) code lists for use in the Learning Delivery Funding and Monitoring fields
The appendices to the ILR specification for 2016 to 2017	
Appendix A	Collection timetable
Appendix B	Migration mapping from 2015/16 to 2016/17 ILR format
Appendix C	Valid postcode format
Appendix D	Domicile codes
Appendix F	Privacy notice
Appendix G	Prior attainment levels
Appendix H	Learning aim class codes
Appendix L	SOC 2000/2010 codes
Appendix Q	Learning outcome grade code list

6. The following documents and links also contain useful information:

Information	Web Address
SFA funding rules	https://www.gov.uk/government/collections/sfa-funding-rules
SFA funding rates and formula	https://www.gov.uk/government/collections/sfa-funding-rates

Information	Web Address
EFA funding regulations	https://www.gov.uk/16-to-19-education-funding-guidance
Learning Aims Search (LARS)	https://hub.imservices.org.uk/Learning%20Aims/Pages/default.aspx
The Funding Information System (FIS)	https://www.gov.uk/government/publications/individualised-learner-record-ilr-check-that-data-is-accurate
feconnect	http://feconnect.sfa.bis.gov.uk/
The Hub, provider web portal	https://hub.imservices.org.uk/Pages/default.aspx
Success Rates Methodology	https://www.gov.uk/government/publications/sfa-qualification-success-rates-business-rules

1.2 Feconnect

- Feconnect** is the SFA's online network for those working with data in the further education and skills sector. It is a forum for you to talk to colleagues about funding or data issues and help each other resolve queries. A sample page from the forum is shown in Figure 1 below.
- By registering as a **feconnect** member you will be able to post questions or comments. Members also get a weekly round-up of FE funding and data news. We occasionally use **feconnect** to ask for your feedback on funding or data issues.
- If you have any queries about **feconnect**, please email feconnect@sfa.bis.gov.uk

Welcome to feconnect

feconnect is a forum for you to talk to colleagues about funding or data issues and help each other resolve queries.

feconnect is administered by the [Skills Funding Agency](#). Please [email us](#) if you have any feedback or would like to report anything you see on the site that you think is inappropriate. [Sign up](#) to join in with the latest discussions.

Recent discussion topics

Viewing 15 topics - 1 through 15 (of 3,146 total)

Topic	Voices	Posts	Freshness
SFA Eligibility for Funding	3	4	3 minutes ago
Btec NQF Level 1/2 achievement	2	2	3 minutes ago
Planned hours for non-workplace provision	3	15	2 hours ago
feconnect blog 22 April 2016	1	1	2 days, 22 hours ago
Funding Eligibility Evidence	5	8	2 days, 22 hours ago
RE-START FOR STUDY PROGRAMME	6	23	2 days, 23 hours ago
Learner Support (DLS)	2	2	3 days, 4 hours ago
EFA Funding Rules vs SFA Funding Rules 2016/17	2	3	3 days, 19 hours ago
AGE Grant LDM code	3	5	3 days, 21 hours ago
QSR National success rates	2	2	3 days, 22 hours ago

Recent Blog Posts

- Apprenticeship levy, advanced learner loans toolkit and ILR docs
- Support manual improvements and this week's publications
- SFA supplementary data collection and future apprenticeship impact survey
- feconnect new features, 2014 to 2015 QAR and publications
- Provider Digital Service blog: agreeing contracts online

Twitter @SFAdata

Figure 1: Feconnect

Section 2: What is the ILR data used for?

10. Data recorded on the ILR return is used to calculate funding earned by the provider and enable comparison of actual volumes and costs against contracted levels.
11. The data provides management information, including performance indicators, which are used to manage the current programmes and also to assist with the development of future programmes.
12. The data gathered provides information on the effectiveness of the learning programmes in terms of who they reach, what learning they receive, and what outcomes are subsequently achieved.

2.1 The requirement for data

13. The data collected in the ILR is used to ensure that public money distributed through the SFA and the EFA is being spent in line with government targets for quality and value for money, for planning, and to make the case for the sector in seeking further funding. Specifically, the data is used to:
 - monitor individual provider's delivery against allocation or contract
 - inform local decisions about plans and provision
 - monitor progress to targets
 - to give the SFA assurance that the funding rules are being followed
 - inform national planning, including policy development and modelling
 - calculate actual funding earned
 - monitor quality of provision and evaluate the effectiveness of providers across the learning and skills sector
 - make the case to government for levels of funding appropriate to the sector
 - demonstrate the outcomes of distribution of government funds.
14. The data will be analysed in relation to:
 - demographic trends
 - participation rates
 - local labour market requirements
 - strategic planning targets.
15. These analyses will enable the funding bodies to:
 - influence curriculum and capital investment within providers for the benefit of the local economy
 - engage with providers in medium and long term strategic planning.

Section 3: Coverage of the ILR

16. All providers must return ILR data for learners for whom they receive direct funding from the EFA or SFA through any of the following funding models:
 - 16-19 EFA
 - Adult skills
 - Community Learning
 - European Social Funding (ESF)
 - Apprenticeships (from 1 May 2017)
 - Other SFA funding, or
 - Other EFA funding.
17. This includes learners who are subcontracted out to other providers. See the [Subcontracted-out Provision](#) section for further information.
18. Providers must also return ILR data for learners who are financed by Advanced Learner Loans. See the [Advanced Learner Loans](#) section for further details about the data requirements for loans learners.
19. There are some circumstances in which learners who are not funded by the SFA or EFA must be included in ILR returns. See [Learning that is not funded by the SFA or EFA](#) for more details.

3.1 16-19 EFA funding

20. The EFA fund 16-19 year olds. The EFA is also responsible for funding provision for learners aged 19-24 who have an Education Health Care Plan or Learning Difficulty Assessment (please note that as of 1 September 2016 Learning Difficulty Assessments will be discontinued). See the EFA funding regulations for full details of EFA funding, <https://www.gov.uk/16-to-19-education-funding-guidance> and the [high needs funding arrangements 2016 to 2017](#).
21. All learning aims undertaken as part of a study programme must be recorded on the ILR.
22. EFA funded study programmes are recorded using code 25 in the Funding model field.
23. See Section 14: EFA study programmes for further details of how to record data for an EFA funded study programme.

3.2 Adult skills funding

24. The Adult skills funding model supports flexible and responsive provision to learners and employers.
25. Adult skills funded learning is recorded using code 35 in the Funding model field in the ILR.
26. From 2016 to 2017, workplace learning is no longer identified in the ILR as per the [Funding Rules](#).
27. If the learner is 19 or over when they start, and the learning is at level 3 to 6, and is not an Advanced-Level or Higher Apprenticeship, then the provision is not supported by the Adult skills funding model but may be supported by a Loan (see the [Advanced Learner Loans](#) section).

Apprenticeships

28. Apprenticeship **frameworks and standards** can be delivered at different levels, including: Intermediate-level Apprenticeships, Advanced-level Apprenticeships, and Higher **and Degree** Apprenticeships.
29. Each apprenticeship programme comprises of a programme aim and one or more component aims. **For apprenticeship frameworks, these components are:** competency, knowledge and functional skills aims.
30. Further information on SFA funded programmes is available on the SFA website at <https://www.gov.uk/apprenticeships-guide>.
31. **See Section 12 for guidance about recording apprenticeship programmes** started prior to 1 May 2017. For funded apprenticeship started on or after 1 May 2017, refer to the [Guidance for returning apprenticeships on the ILR from 1 May 2017](#).

OLASS funded learners

32. **Data collection arrangements for provision delivered through the Offenders' Learning and Skills Service (OLASS) are currently pending the outcome of an independent review of prison education. Guidance for this provision will be updated once this review has concluded.**
33. All OLASS learning aims should be identified using code LDM034 in the [Learning Delivery Funding and Monitoring](#) fields.

3.3 **Former Community Learning**

34. **Former** Community Learning funding is for learners aged 19+. Learners who are under 19 should be funded only where they are the parent on a family learning programme. If the parent is under 16, providers should keep documentation for audit purposes, as it is an 'exceptional case'.
35. **The funding rules for Former Community Learning are set out in an appendix to your funding agreement.**
36. **For Former Community Learning activity claimed using the 'non-formula funded' approach, ILR data must be recorded using Funding model code 10 and [Learning Delivery Funding and Monitoring](#) (FAM) records to identify Personal and Community Development Learning (PCDL), Neighbourhood Learning in Deprived Communities (NLDC), Wider Family Learning (WFL) and Family English, Maths and Language (FEML). For Former Community Learning activity delivered through the Adult Education Budget (AEB) formula funded approach, you do not need to record these FAM codes.**
37. **Former** Community Learning provision that is subcontracted to an FE College by a local authority must be recorded by the College using code 99 in the Funding model field, with a [Learning Delivery Funding and Monitoring](#) code of SOF108.
38. The data collection requirements are the same for all **Former** Community Learning provision, regardless of whether it is directly funded or subcontracted.
39. Where Family English, Maths or Language (FEML) learning aims are delivered through the AEB, these should be identified using the Learning Delivery FAM type of 'Family English, Maths and Language' (FLN). FEML programmes that are funded through the Community Learning funding model must be recorded using the Learning Delivery Funding and Monitoring type of 'Community Learning provision type' (ASL).
40. All provision recorded as FEML (with Learning Delivery FAM type of either FLN or ASL) must meet the definition of FEML provision in the ILR Specification.

3.4 European Social Fund (ESF)

41. ESF funded learning is identified in the ILR using code 70 in the Funding model field.
42. ILR data provides information to manage and calculate ESF funding. The data derived is also used to manage and monitor ESF funded provision and to inform the development of future policy. Where relevant, the data is also used to substantiate ESF funding claims.
43. ILR data is also used to produce the ESF Programme Management Information (MI) which is submitted with each ESF claim to the ESF Managing Authority and then to the European Commission. For the 2014 to 2020 ESF Programme, the MI for common outputs and results indicators is set by [Regulation \(EU\) No 1304/2013 of the European Parliament and Council](#). The SFA has a statutory obligation to collect this information for ESF funded learners and those learners that are used, or could potentially be used, as match funding.
44. Section 15 contains guidance on ESF funded learning aims, including match funding and amending data.

3.5 Traineeships

45. The traineeship programme helps unemployed young people aged 16-24 to develop the necessary skills and experience to progress to an apprenticeship or long-term work.
46. Traineeships are funded through both the EFA 16-19 funding model and Adult skills funding model.
47. Please see Section 13 for full details of how to record a traineeship on the ILR.

3.6 Learning that is not funded by the SFA or EFA

48. All providers must return an ILR for Higher Education Funding Council for England (HEFCE) funded learners.
49. There are also some circumstances, detailed below, in which non-funded learners are included in the ILR.

Requirements for Further Education (FE) Colleges

50. FE Colleges must send data for **all** learners, including those that are not funded by the EFA or SFA. This includes:
 - full cost recovery provision, where the full cost of the learning is met by the learner or their employer;
 - learning aims that are delivered by the college on behalf of another college or training provider who is in receipt of direct EFA or SFA funding (subcontracted-in); and
 - Community Learning provision that is subcontracted-in to the FE College by a Local Authority (LA).
51. The types of learning aims outlined above should be recorded using code 99 'No SFA or EFA funding for this learning aim' in the Funding model field, and the Source of funding should be identified as code 998 'Other' in the [Learning Delivery Funding and Monitoring](#) record unless the provision is Community Learning subcontracted from a Local Authority, in which case Source of funding code 108 should be used. **If the provision is full cost recovery (where the full cost of the learning is met by the learner or their employer), then the Source of funding does not need to be returned.**

Example

A training organisation receives funding from the SFA but subcontracts provision for 10 learners to Casterbridge College i.e. the provision is subcontracted-in to Casterbridge.

Casterbridge College would include records for the 10 learners in its ILR return with the following coding:

Funding model = 99 (No SFA or EFA funding for this learning aim)

Source of funding = SOF998 (Other)

Non-funded apprenticeships

52. Training organisations are asked to send details of apprenticeships (including both frameworks and standards) that are not funded by the SFA as follows:

- where they are delivered within the terms of a SFA contract
- in other cases on a voluntary basis.

Requirements for Higher Education (HE) Institutions

53. **The following requirements apply to non-apprenticeship provision only. If you are delivering higher and degree apprenticeships, please see Section 12 or the [Guidance for returning apprenticeships on the ILR from 1 May 2017](#) for the data return requirements.**

54. All Higher Education Institutions (HEIs) that receive funding from the SFA and/or EFA should make returns to the Higher Education Statistics Agency (HESA), which collects data on behalf of the Higher Education Funding Council for England (HEFCE). The HESA and the SFA exchange data, thus avoiding duplicate requests for data.

55. Ideally, an HEI would send a record for a student to one data collection agency (either in the form of student records to the HESA or in the form of ILRs to the SFA). Where this is not possible, due to the mix of provision the student is following, care must be exercised to ensure that records of any particular instance of study (“instance”) are included in the data sent to only one of the agencies.

56. Where a HEI makes a return to both collection agencies, it should be aware that the SFA and the EFA will use only the data returned to the SFA for funding purposes.

Advanced Learner Loans

57. Advanced Learner Loans help people aged 19 or over to undertake FE learning aims at levels 3 to 6. Please refer to the [Advanced Learner Loans funding and performance management rules for 2016 to 2017](#) for further information on Advanced Learner Loans.

58. ILR records must be sent for all learners and learning aims financed by an Advanced Learner Loan.

59. Learning aims that are financed by an Advanced Learner Loan must be recorded using code 99 in the Funding model field with a [Learning Delivery Funding and Monitoring](#) indicator of ADL1.

60. **Some learning aims financed by an Advanced Learner Loan may require Higher Education (HE) data to be returned on the ILR. See Section 9.11 for the HE dataset requirements.**

Advanced Learner Loans Bursary

61. In addition to an Advanced Learner Loan, learners can also be in receipt of an Advanced Learner Loans Bursary. The Loans Bursary Fund is a separate SFA allocation.

62. The Advanced Learner Loans Bursary should be recorded on the ILR in the [Learning Delivery Funding and Monitoring](#) fields.

63. The dates for which the learner is claiming the loans bursary need to be recorded using the Date applies from and Date applies to fields. Further details of these fields are on page 48.
64. For contract funded providers, the bursary will be paid monthly based on ILR returns up to the level of your contract.
65. For providers funded through a grant, the bursary allocation is paid on profile and reconciled at the end of the year; any unspent funds must be repaid. If the learner requires learner support, this should also be recorded in the Learner Funding and Monitoring fields using FAM type LSR (Learner support reason).
66. Please refer to the [Advanced Learner Loans funding and performance management rules for 2016 to 2017](#) for payment and performance management arrangements.

3.7 Subcontracted provision

Subcontracted-in provision from a school or HEI (FE Colleges only)

67. A Further Education (FE) college should not return ILR records for learners enrolled at a school even if the learners are studying provision delivered by the college on behalf of the school at which the learner is enrolled.
68. Learners who are subcontracted-in to an FE college from an HEI for provision at level 4 or above must not be included on the ILR.

Subcontracted-in provision from another provider (FE Colleges only)

69. Learners who are subcontracted-in from another provider (not a school or HEI) should be included in the ILR.
70. Learners who are undertaking HE provision and are subcontracted into an FE college from another FE college must not be included in the ILR.
71. Learning aims must be recorded as receiving 'No SFA or EFA funding for this learning aim' in the Funding model field with code 99. The Source of funding must be identified in the [Learning Delivery Funding and Monitoring](#) fields with code SOF998, unless the provision is Former Community Learning subcontracted from a Local Authority, in which case Source of funding code 108 should be used.

Subcontracted-out provision (All providers)

72. Providers may provide teaching and learning to learners that they enrol either directly or through a partnership or subcontracting arrangement with another organisation (subcontracted-out).
73. The Subcontracted or partnership UKPRN field must be completed to indicate if any proportion of the learning aim is delivered by a partner provider.

3.8 Definition of provider type

College	<p>A further education corporation established under the Further and Higher Education Act 1992. This covered GFEs, Tertiary, Sixth-form, Specialist Colleges, and Academies.</p> <p>This definition will be extended to include the new status of Sixth Form Colleges established under the ASCL Act 2009.</p> <p>Local authorities (county, borough, district and city councils and unitary authorities in England) and Higher Education Institutions (HEIs) are also included in this definition for data collection purposes.</p> <p>These providers may also be referred to as grant funded providers</p>
Training organisation	<p>An organisation whose main area of business is education and/or training but which is not a college or local authority.</p> <p>These providers may also be referred to as contract funded providers.</p>

Section 4: How to collect ILR data

74. Providers can collect the data required to make an ILR return in whatever way they wish to and in the best way that supports their natural business processes. For example, information about the learner may be gathered on a paper enrolment form or through an online enrolment process. Much of the information about the learning aims and programmes being undertaken may be held within a provider's Management Information System (MIS) and can be exported directly from this.
75. To assist providers in collecting the correct data for different types of learners, a list of the fields required for each funding model is given in Section 18: Field collection requirements tables.

Data protection requirements

76. Providers should make sure that all learners have seen the Privacy Notice, which informs them about how their data will be used. The Privacy Notice can be found in *Appendix F of the ILR Specification 2016 to 2017*.
77. Providers should ask learners if they do not wish to be contacted for marketing, survey or research purposes and record this information in the [Learner contact preference](#) fields in the ILR.
78. Providers are required to ensure that the requirements of the Data Protection Act are maintained at all times.

Learning Agreements

79. All learners must have a learning agreement.
80. The SFA funding rules provide detailed information about the requirements for the [learner file \(previously called Learning Agreement\)](#) for SFA funded learning and are available at: <https://www.gov.uk/government/publications/sfa-funding-rules>
81. The EFA funding regulations document, which includes their funding compliance guidance in relation to learner recruitment, existence, retention and achievement is available at: <https://www.gov.uk/16-to-19-education-funding-guidance>

Paper forms

82. All ILR data is required to be reported electronically to the SFA, however providers may at point of contact with the learner use a paper form to capture data about the learner and this may form part of their Learning Agreement.
83. Providers are encouraged to use their own processes to gather ILR data which best meet the needs of their organisation. This may not involve the use of paper forms at all.

Section 5: Data management principles and ILR completion

84. Data underpins funding and commissioning decisions, and it also underpins and informs the work of Ofsted and other agencies. When aggregated, it presents the progress and position of the sector to sponsoring departments and to the Government, thereby informing policy making decisions.
85. Set out below are the five Data Management Principles and what each means in relation to the completion of the ILR.

Principle 1: The ILR must accurately describe the provision delivered to each learner.

86. The ILR must accurately reflect the journey for the learner and what has happened. Inaccurate information must never be entered even where it is perceived that this would result in a more equitable claim for funding or accurate record of performance.

Principle 2: The ILR must accurately and comprehensively reflect what is recorded in each learner's learning agreement.

87. For all providers, the learning agreement records the goals that the learner and provider have agreed. It is against these goals that provider performance, in terms of success rate, is measured.
88. It is recognised that the learning aim may be agreed during the initial period of learning for long qualifications but once set it must not be changed. It is reasonable to expect that the goal should be agreed as soon as possible.
89. Consequently, providers must agree and record the learning aim within the funding qualifying period as defined in the EFA or SFA funding documentation. There is one exception for English for speakers of other languages (ESOL).
90. Where a provider and learner agree to a change of aim after delivery of the aim has commenced and the funding qualifying period has passed, then it must be recorded as a transfer in the ILR.

Principle 3: For any particular return, a provider must meet the timeliness specification.

91. For data for which there is a collection reference date on the timetable, a provider must accurately describe in the ILR all provision delivered up to and including the collection reference date. The provider may include data for provision delivered after the reference date
92. For returns, which do not have reference dates, the provider must return new starters, leavers and changes in a timely way as described in section 7.3.1 of this document.
93. Where data describes provision to be delivered in the future, that is beyond the reference date or beyond that required to meet the timeliness standard, no one should assume this data is complete or accurate.

Principle 4: Basic pieces of information about a learner and their learning must remain constant once entered in the ILR except where the information has been entered in error.

94. In particular the following fields should not be changed without keeping a record of the reason for the change: Postcode prior to enrolment, Learning aim reference, Funding model, Learning start date, Planned learning hours and Planned employability, enrichment and pastoral hours. The Learning planned end date field must not be changed once set and this is stated specifically in the ILR specification.
95. Where inaccurate data is sent, Principle 1 takes precedence. That is, it is more important to correct incorrect data than to not change fields.

Principle 5: Providers should aim to implement data management best practice when processing learner data within their systems in order to deliver timely and accurate data in their ILR.

Section 6: Sending data to the Skills Funding Agency

96. All providers need to send ILR data to the SFA by uploading an XML file to The Hub web portal: <https://hub.imservices.org.uk/Pages/default.aspx>
97. Providers produce a batch file from their MI system and load it to the SFA via the Hub. For providers who do not have an MIS system capable of generating an XML file, the SFA provide an ILR Learner Entry Tool which can be used to create an ILR file for upload to the Hub. The Learner Entry Tool can be accessed from the Useful links section on the Hub: <https://hub.imservices.org.uk/Pages/default.aspx>
98. **Providers are encouraged to send data regularly and not wait until a return date to transmit data.**
99. **It is best practice to upload an ILR file early in the return period to allow enough time to resolve any validation errors and warnings.**
100. If you are experiencing problems uploading an ILR file, you should contact the SFA as soon as possible. For contact details, see: <https://www.gov.uk/government/publications/sfa-data-services-help-and-support>

6.1 File compression

101. Providers are advised to upload their ILR returns using compressed files. Compressed files, sometimes referred to as archives or zip files, contain a version of the ILR data that is significantly smaller than the uncompressed XML file. Upload times are shorter, which benefits all providers and contributes to maximum reliability of the service.
102. Each compressed file should contain one ILR XML file only. The file should not be encrypted or password protected. The name of the zip file should be the same as the name of the XML file but with the extension .zip instead of .XML.

6.2 ILR file transmissions

103. File transmissions must contain all Learner records, Learning Delivery records and Learner Destination and Progression records, for all learners at the provider, for the year to date, for that return.
104. **Sections 7.1 and 7.2 describe what data should be included in ILR returns.**
105. Providers may need to use the amalgamation facility in The Funding Information System (FIS) when they send an ILR file containing all learner records from all funding streams, see section 6.4 for more information about the FIS.
106. Providers should note that subsequent transmissions will overwrite all the records previously transmitted for that provider that are held in the national database. This means that providers cannot split their data into separate files and transmit each file separately. A provider cannot send records for learners funded from different funding models in separate files, as they will overwrite one another. One file must be sent containing all learners from all funding models.
107. Destination and Progression data cannot be sent in a separate file to Learner and Learning Delivery data, as this will also result in the Learner and Learning Delivery records being deleted from the ILR database.
108. Care must be taken to ensure that data is not overwritten in error.

6.3 The impact of incomplete information

109. The transmission of ILR data containing omitted, incomplete or incorrect entries may result in the learner record not being accepted onto the national ILR database. The return of ILR data, promptly, fully and accurately completed, is essential.
110. Any data for individual SFA funded learners not accepted by the national ILR database will mean that the Provider Funding Report will not show their details and may result in non-payment or clawback in that period for providers paid on actuals.
111. Funding calculations and provider payments for all SFA funded learning aims are based directly on the data provided in the ILR. Any inaccurate or late information may result in payments not being made. It is important to ensure that all documentation relating to the enrolment of the learner and the record of learning activity is completed accurately and conforms to the eligibility rules of the appropriate type of learning programme.

6.4 The Funding Information System (FIS)

112. The FIS is a standalone piece of software produced by the SFA that providers can download onto their own PCs. It contains the ILR Validation rules and allows providers to check their ILR data before sending it to the Hub. The FIS also contains the funding calculations for both the EFA and the SFA and enables a number of reports to be run and downloaded based on a provider's data.
113. The FIS includes the facility to amalgamate separate files to create a single XML file.
114. Information on the latest FIS software can be found at:
<https://www.gov.uk/government/publications/individualised-learner-record-ilr-check-that-data-is-accurate>

6.5 Combining ILR files (amalgamation)

115. Some providers may have multiple MI systems across their organisation, for example, SFA funded learners and their learning aims may be held in a separate system to EFA funded learners and learning aims. The FIS includes an amalgamation facility to combine multiple files to create a single XML file for all learners. Providers can also use their own software to create their own single file if they wish to do so.
116. The amalgamation facility in FIS will join together learner records from multiple ILR files for learner records that have the same Learner reference number. For the records to be successfully combined into a new single learner record, all the data in the Learner fields on all of the records must be the same. Any conflicting learner data will result in an amalgamation error which will need to be corrected. For example, if the Date of birth has been incorrectly recorded on one record and does not match the Date of birth on the other record then an amalgamation error will be generated and the records will not be combined.
117. When providers have multiple internal departments that all send data separately, care should be taken in case a file submission from one department overwrites a file sent by another department. Providers in this situation may need to use the amalgamation facility in FIS to join the different files together into a single file.
118. Where data for the same learner has been held in separate systems but with different Learner reference numbers, providers are encouraged to return a single combined learner record.

119. If the provider decides to merge two or more records for the same learner, they may use any one of the learner's previous Learner reference numbers. Any changes to a learner's Learner reference number from one teaching year to the next must be recorded using the ILR field 'Learner reference number in previous year'. This will enable data matching over multiple teaching years for a learner to be carried out for purposes such as success rate calculations. See the *ILR Specification for 2016 to 2017* for further details and collection requirements for this field.
120. Providers which take over the delivery of provision for learners from other providers, for example as a result of the Minimum Contract Level, should note that two learners cannot be returned against the same Learner reference number.

6.6 Data validation

121. It is important that the data received is accurate. The SFA runs validation checks to make sure that data is complete. ILR files are validated at the point of transmission to the Hub or through the FIS against both the XML schema definitions and validation rules.

XML schema validation

122. There are two stages to the XML schema validation.

Stage 1: The ILR file is checked for the following:

- that the XML is well-formed. Well-formed means that the file adheres to XML's strict syntactical rules for open and close tags and the nesting of data elements
- elements are presented in the expected sequence, as defined in the schema
- an element conforms to its data type. Examples of this would include where a numeric item contains alpha characters, or where a date contains invalid values.

123. If any part of the file fails any of these checks then it will not be processed further and the whole file will be rejected and the errors reported on the rule violation report.

Stage 2: The individual elements (fields) within the file are checked for the following:

- all mandatory fields have been returned
- field lengths are adhered to
- data patterns are adhered to.

124. If a field fails any of these checks then the learner record, and associated records for that learner only, will be rejected and reported on the rule violation report.

125. The published XML schema contains all the definitions and requirements for both stages of schema validation.

126. Schema errors are reported on the rule violation report, however the error messages generated are generally briefer than those for other validation errors.

127. Only learner records, and associated records for that learner, that have passed schema validation will be passed through to validation against the Validation Rules.

Validation rules

128. Validation rule errors are produced where data does not make sense or cannot be correct. Learner records that produce errors are not loaded into the national ILR database and will need to be corrected by the provider. All valid learner records will be accepted.

129. Validation errors are reported on the validation error reports which are produced in the FIS and on the Hub. Providers should make sure that they check these reports after uploading an ILR file. Validation errors that start “FD_” indicate data that is breaking schema restrictions. You should check this data against the definition of the field in the ILR Specification.
130. All learning aims returned for a learner must be valid, regardless of the type of funding. For example, if EFA funded learning aims are included alongside SFA funded learning aims in a return at the start of the year (before December 2016), then all of these aims must be valid in order for the learner records to be accepted.
131. Validation rule warnings are produced where the data is unusual, for example where a learner is over 100 years old. Records that produce warnings are loaded into the national database, however providers are encouraged to check each of these records to ensure that the data is correct. Where warnings have been produced due to erroneous data (e.g. erroneous postcodes), this data should be corrected.
132. Some validation rule checks are not included in the FIS and only take place when data is uploaded to the Hub. These are rules that check external tables, such as the Unique Learner Number (ULN), Employer identifier and postcode validation.
133. The Validation rules for 2016 to 2017 are published at:
<https://www.gov.uk/government/publications/ilr-specification-validation-rules-and-appendices-2016-to-2017>

Postcode validation

134. It is important that postcodes are correctly formatted; this includes the space between the two parts of the postcode. Postcodes with two spaces will fail validation when the data is uploaded to The Hub. *Appendix C of the ILR Specification 2016 to 2017* contains further information on the postcode format.
135. Most postcode fields in the ILR are mandatory fields and cannot be left blank. For mandatory postcode fields, if the postcode is unknown or does not apply then a value of ZZ99 9ZZ should be recorded.

Provider data self-assessment toolkit

136. The provider data self-assessment toolkit (PDSAT) produces a suite of reports to test the integrity of ILR data in order to assist providers in identifying potential anomalies or errors in their data.
137. Within the suite, the SFA includes reports that enable providers to identify errors relating to its monitoring of the funding rules. The SFA uses a similar set of reports to routinely monitor the ILR data, to identify potential errors, and for assurance that providers are complying with the funding rules.
138. Although providers are not contractually required to use PDSAT, they may find it useful for routine data cleansing, identifying errors and preparing for financial assurance visits. PDSAT is designed to give providers a toolkit to review their ILR data and to assist auditors in the audit of providers' data
139. The current PDSAT download and guidance can be found at:
<https://www.gov.uk/government/publications/ilr-data-check-that-it-meets-standards-and-quality-requirements>

6.7 Earnings adjustment statement (EAS)

140. The Earnings Adjustment Statement (EAS) is an online process that providers can use to claim SFA funding that is not reported in the ILR.
141. The SFA funding rules 2016 to 2017 give further information on categories within the EAS and their evidence requirements. These rules can be found at:
<https://www.gov.uk/government/collections/sfa-funding-rules-2016-to-2017>
142. The EAS is available for collection periods corresponding to the 12 months of the funding year. Funding for period 1 is added to funding from the ILR from August on the Funding Summary Report, period 2 funding is added to funding from the ILR for September, and so on. The total amount of funding claimed in each of the collection periods' EAS will be summarised to calculate the total for the funding year.
143. There are different expectations on how regularly EAS returns are submitted depending on whether the return is for a contract funded provider or a grant funded provider. See the guidance on the EAS for further details.
144. Further information and guidance on the Earning Adjustment Statement can be found at:
<https://www.gov.uk/government/collections/individualised-learner-record-ilr>

Section 7: Returning Data in 2016 to 2017

7.1 What to return

145. The following paragraphs describe the Learning Delivery data that should be included in the 2016 to 2017 ILR data returns.

Aims that are not part of a traineeship or apprenticeship programme

146. The 2016 to 2017 ILR must include:

- aims that are continuing (Completion status = 1 and Learning actual end date is null)
- aims that are completed or withdrawn from during the 2016 to 2017 teaching year (Completion status = 2 or 3, and Learning actual end date is on or after 1 August 2016 and before 1 August 2017)
- aims that were completed in the previous teaching year where the outcome is not yet known (Learning actual end date has been completed and is before 1 August 2016 and Outcome = 8 “learning activities are complete but the outcome is not yet known”)
- aims where the learner is on a break in learning (Completion status = 6)

Aims that are part of a traineeship or apprenticeship programme

147. For traineeship and apprenticeship programmes, the ILR must include the programme aim and all associated component aims (with matching ProgType, FworkCode and PwayCode, or StdCode code) even if the component aims are completed and closed.

148. The completion status of the programme aim is used to determine whether the data should be returned, the 2016 to 2017 ILR must include all aims for:

- programmes that are continuing (Aim type = 1, Completion status = 1 and Learning actual end date is null)
- programmes that are completed or withdrawn from during the 2016 to 2017 teaching year (Aim type = 1, Completion status = 2 or 3, and Learning actual end date is on or after 1 August 2016 and before 1 August 2017)
- programmes that were completed in the previous teaching year where the outcome is not yet known (Aim type = 1, Learning actual end date has been completed and is before 1 August 2016, and Outcome = 8 “learning activities are complete but the outcome is not yet known”)
- programmes where the programme aim is completed (Aim type = 1, Completion status = 2, and Learning actual end date is completed), and the learner is continuing with an English or maths aim
- programmes where the learner is on a break in learning (Aim type = 1 and Completion status = 6)

Additional guidance

149. Providers must include all learners who have attended one episode of learning. If the learner withdraws without completing one episode of learning - for example, without attending the first class - then they must not be included in the ILR.

150. Your ILR returns must include all aims that meet the criteria above, and any aims from the previous year that have since been corrected (see section 11.2). For example, you must return learning aims where a learner was recorded at the start of the year with a Learning actual end date before 1 August 2016 and on a break in learning (Completion status = 6) and this record is updated during the year because the learner has since been identified as withdrawn (Completion status = 3).

151. Any aims reported as continuing in the final return (R14) for 2015 to 2016 that are not reported in 2016 to 2017 will be treated as withdrawn in the qualification achievement rates (QARs) for 2016 to 2017.

7.2 Completing the final return for 2016 to 2017

152. The final return for the 2016 to 2017 year allows providers to send details of the outcomes of learning aims that were completed up to and including 31 July 2017.

153. Your final ILR return must include all Learner, Learning Delivery and Learner Destination and Progression data that has been returned during the year, including all records described in section 7.1 and any records that have been amended during the year (for example, to correct data errors: see section 11.2).

154. Achievement funding and Job outcome funding for learning aims funded through the Adult skills funding model that are completed in 2016 to 2017 (that have an Actual end date up to and including 31 July 2017) will only be paid if the achievement is reported in the 2016 to 2017 returns.

155. For traineeship programmes which start and are completed in 2016 to 2017, the learner must demonstrate a positive destination within 6 months of completing the programme in order to record a programme achievement. If the Achievement date is before 1 August 2017, then this positive destination must be reported in the 2016 to 2017 ILR returns in order to earn achievement funding.

156. The following should **not** be returned in the final return for 2016 to 2017, but should be returned in the 2017 to 2018 ILR returns:

- learning aims that start after 31 July 2017
- actual end dates after 31 July 2017
- achievement dates after 31 July 2017

7.3 When to return ILR data

157. The timetable for collection of the ILR data is published in *Appendix A of the ILR Specification for 2016 to 2017*.

158. The SFA holds ILR data for all providers in a single national data collection database. This database contains the most up to date ILR data for each provider. At certain points in the year, the SFA will extract data from this national ILR database for various purposes.

159. A provider must ensure that the data held on the national database is complete and fit for purpose by the return date. This return date is a hard close date for including data for the purposes described. Should a provider fail to complete and return the data by the return date, then any data sent after that date will not be processed for the purposes of that particular return.

160. The return dates in *Appendix A* represent the last opportunity to send data for each return.

161. For FE Colleges and other grant funded providers, 16-18 apprenticeship data, 19+ apprenticeship standards data, ESF data and data for apprenticeships started on or after 1 May 2017 is required monthly. Each college must decide for itself what data it sends in addition to the data essential to meet that required at any particular return date.
162. Some colleges may find it easier to send full returns at each return date after the first full return in R04 rather than attempting to extract and send data only for provision requested at a particular return. However, this is a decision that each college must make for itself.
163. If there are no changes to a provider's data since the previous return then there is no requirement to send another return.
164. At a return where data is requested only to drive payment for 16-18 apprenticeships, 19+ apprenticeship standards, apprenticeships started on or after 1 May 2017 or ESF provision, then data for this provision needs to be complete and error-free, while data for other provision that is sent in the same file can be both incomplete and contain errors.

7.3.1 The ILR timetable for 2016 to 2017

165. The ILR timetable can be found in *Appendix A* at:
<https://www.gov.uk/government/publications/ilr-specification-validation-rules-and-appendices-2016-to-2017>
166. The ILR timetable sets out:
- the return date by which a provider must send complete data for the purposes described in the timetable
 - the purpose of the return and which agency will receive the data
 - which providers need to send data for the particular return
167. All data held must be up-to-date for the purposes described in the timetable by 6pm on the fourth working day of the month.
168. For any particular return, a provider must accurately describe in the ILR all provision delivered up to and including the collection reference date. Providers may include data for provision delivered after the reference date. For returns which do not have reference dates, the provider must return new starters, leavers and changes in a timely way. Starts must be reported within 2 reporting months and achievements within 3 reporting months.
169. The type of provider determines when data returns are required. In broad terms, colleges are required to send data on a quarterly basis and training organisations on a monthly basis. 16-18 apprenticeships, 19+ apprenticeship standards, apprenticeships started on or after 1 May 2017 and ESF funded aims are returned on a monthly basis (excluding the R14 return) regardless of the type of provider.

Skills Funding Agency actual earned process

170. The Actual Earned process is scheduled to run overnight following close of business on the return deadline date. Providers will receive any payment due on the eleventh working day following the end of the month. This represents the value earned to date, subject to a maximum contract value.

Section 8: Data migration for continuing learners

8.1 Migrating data from 2015 to 2016

171. Migration is the process by which ILR data is converted from the 2015 to 2016 ILR format into 2016 to 2017 ILR format for continuing learners from 2015 to 2016.
172. *Appendix B of the ILR Specification* contains the conversion rules for data migration.
173. For most providers, their Management Information System (MIS) supplier will migrate their data ready for 2016 to 2017 data transmissions.
174. The SFA does not carry out any form of data migration from one teaching year to the next. Therefore, it is important that all providers send data in the first return for 2016 to 2017, otherwise there will be no data held for them in the 2016 to 2017 database and their funding for the year may be affected.
175. The following fields need to be completed annually on the ILR, where applicable. This data will need to be **reviewed and set at the start of 2016 to 2017**:
 - Accommodation
 - Learning support cost
 - Planned learning hours
 - Planned employability, enrichment and pastoral hours
 - GCSE maths qualification grade
 - GCSE English qualification grade
 - High needs students indicator (Learner Funding and Monitoring type)
 - Learner support reason (Learner Funding and Monitoring type)
 - Special educational needs (Learner Funding and Monitoring type)
 - GCSE maths condition of funding (Learner Funding and Monitoring type)
 - GCSE English condition of funding (Learner Funding and Monitoring type)
 - Free meals eligibility (Learner Funding and Monitoring type)
 - Pupil premium funding eligibility (Learner Funding and Monitoring type)
 - Financial support entity (HE learners only)
 - Net tuition fee (HE learners only)
 - Gross tuition fee (HE learners only)

8.2 Migrating employment status records

176. You only need to migrate employment status records that relate to a learner's current learning. Historic employment status records do not need to be returned.
177. The following employment status records must be migrated:
 1. The employment status record with the Date employment status applies that is the most immediate before the earliest Learning start date or Original learning start date (if completed) of all the learner's aims.
 2. All employment status records that have a Date employment status applies that is after the date of the employment status record identified above.

178. For 2016 to 2017, new validation has been introduced to prevent consecutive records being returned where the only change since the previous record is the Date employment status applies. For example, consecutive records with the same values of Employment status, Employer identifier (including where the Employer identifier has not been returned), Employment status monitoring type and Employment status monitoring code will fail validation.
179. If there has been no change in the learner's employment status, employer, or employment monitoring since the previous employment status record was added then a new record does not need to be returned.

8.3 Coding continuing learners recorded with the WPL indicator

180. For 2016 to 2017, the Workplace learning indicator in the Learning Delivery Funding and Monitoring fields has been removed. Code WPL1 must be removed from learning aims for continuing learners from 2015 to 2016.
181. A small number of workplace learners who started before 1 August 2013 must be identified in the ILR for 2016 to 2017 to ensure correct calculation of completion and achievement funding. Learning aims that meet either of the following criteria must be identified using code LDM350 in the Learning Delivery Funding and Monitoring fields:
1. If code WPL1 was recorded in 2015 to 2016 and the Learning start date is before 1 August 2013 and the Funding model = 35 and the aim is not part of an apprenticeship programme (ProgType <> 2, 3, 10, 20, 21, 22, 23) then you should record a new code of LDM350.
 2. If code LDM125 was recorded in 2015 to 2016 and the Learning start date is before 1 August 2013 and the Funding model = 35 and the aim is not part of an apprenticeship programme (ProgType <> 2, 3, 10, 20, 21, 22, 23) then you should replace LDM125 with LDM350.

8.4 Coding continuing learners on apprenticeship standard programmes

182. For continuing learners on apprenticeship standard programmes, the Trailblazer apprenticeship standard code (recorded in the Learning Delivery Funding and Monitoring fields in 2015 to 2016) must be moved to the Apprenticeship standard code field in the Learning Delivery entity.

8.5 Migration requirements for ESF funded learning and traineeship programmes

183. For the ESF 2014 to 2020 Programme, all records for all learners who have received ESF funding as part of the current programme must continue to be returned for the duration of the ESF programme. This includes all Learner, Learning Delivery, and Destination and Progression records for learners who completed their learning aims in 2015 to 2016. See Section 15 for guidance about returning data for ESF funded learning aims.
184. For traineeship learners who completed their programme in 2015 to 2016 but are continuing with the English and/or maths aim in 2016 to 2017, all Destination and Progression records with an Outcome collection date before 1 August 2016 must be migrated.

8.6 Migration requirements for closed aims

185. Closed aims must be migrated from the 2015 to 2016 ILR into 2016 to 2017 for the following learners. For these learners, all relevant learning aims and destination records must be migrated:

- Where all of the learner's aims are closed and Completion status code 6 (agreed break in learning) has been recorded in 2015 to 2016, and the learner has not returned to learning by 31 July 2016. You must migrate all of the closed learning aims with Completion status code 6 into 2016 to 2017.
- Where all of the learner's aims are closed and Outcome code 8 (not known) has been recorded in 2015 to 2016, and the Outcome is still not known by R14 of 2015 to 2016. You must migrate all of the closed learning aims and any associated Destination and Progression records into 2016 to 2017. The Outcome can be updated in 2016 to 2017 once it is known. This includes data for learners who have finished their traineeship programme but their destination is not yet known.
- For ESF learners, all closed aims and any associated Destination and Progression records must continue to be returned until the end of the ESF programme.
- For traineeship programmes where the programme has been completed but the learner is continuing with their English and/or maths aim, the closed traineeship programme aim and the continuing English/math aim must be migrated into 2016 to 2017. You must also migrate any associated Destination and Progression records for that learner into 2016 to 2017.

Section 9: Completing the ILR

9.1 Introduction to the data model

186. The ILR is based on a data model which defines the entities covered by the ILR and the relationship between these entities. A simplified version of the entity relationships is shown in the diagram in Figure 2 below.

Figure 2: ILR Entity Relationship Diagram

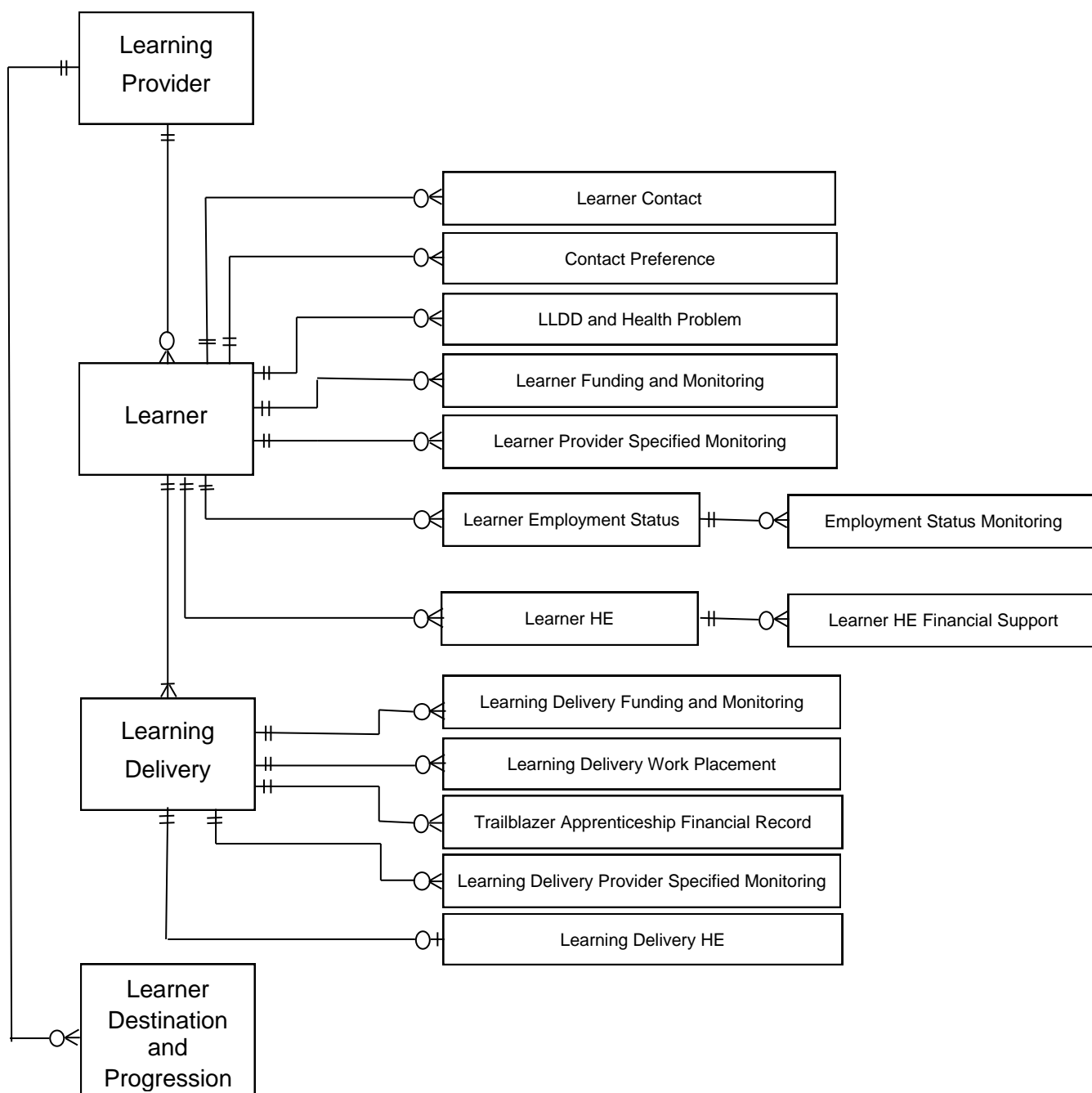

9.2 Learner details: completing the Learner entity

187. A provider should return only one record for each learner. The data recorded in the Learner entity contains basic information about the learner such as their name, date of birth, sex and ethnicity.
188. The learner's name, date of birth and sex should match the data held by the Learning Records Service (LRS). If any of the learner's details change, this should be recorded in the ILR and the data held by the LRS updated.
189. For a full list of changes to the ILR for 2016 to 2017, please refer to the Summary of Changes in the *ILR Specification for 2016 to 2017*.
190. The following entities contain data that may not be required for all learners. See the individual field pages in the specification for data requirement details.
 - Learner Contact – address, telephone number and email details
 - Contact Preference – indicates the learner's wishes about contact for marketing, research and survey purposes
 - LLDD and Health Problem – additional information about a learner's disabilities, learning difficulty and/or health problem.
 - Employment Status and Employment Status Monitoring – monitoring of a learner's employment status
 - Learner Funding and Monitoring – additional data to support funding and learner monitoring
 - Learner Provider Specified Monitoring – additional provider data used as required and specified by the provider
 - Learner HE and Learner HE Financial support – HE data fields

9.2.1 Learner reference numbers

191. Each provider allocates a Learner reference number to each learner. The Learner reference number must be unique. It is used for data reporting between years for continuing learners and for the calculation of success rates. This number must remain allocated to the user for all study with the provider and during periods of absence.
192. A Learner reference number must never be reused for a different learner.
193. A learner should not be allocated more than one Learner reference number.
194. Changes to the Learner reference number between years for continuing learners should be avoided if at all possible.
195. If change to the Learner reference number is unavoidable, the field 'Learner reference number in previous year' should be used to record the learner's reference number if it is different from the previous year. Please see the *ILR Specification* for further details and collection requirements of this field.
196. Providers should also obtain a Unique Learner Number (ULN) for the learner from the [Learning Records Service](#). This is mandatory in the ILR for the majority of funded learners and for learners in receipt of an Advanced Learner Loan. The ULN enables the learner to build a lifelong record of their learning participation and achievements, which they can access and choose to share.

9.2.2 Planned learning hours

197. This field collects the total planned timetabled hours for learning activities for the teaching year. The field is completed at the start of the teaching year or programme and updated annually.
198. It is collected for all learners with learning aims funded by the following funding models
- 16-19 EFA funded (Funding model = 25)
 - Adult skills funded (Funding model = 35)
 - Other SFA funded (Funding model = 81) except apprenticeship standards (Programme type = 25)
 - Community Learning funded (Funding model = 10)
 - **Non-funded (Funding model = 99)**
199. Planned learning hours are not collected for apprenticeship programmes.
200. For learners who are undertaking an EFA funded study programme, the hours fields are not updated in year. See the : EFA study programmes section on page 92 for further details of recording planned hours for EFA study programmes.
201. For learners with only SFA funded aims, this field can be updated in year where a learner progresses to subsequent learning in the same teaching year.
202. If a learning aim continues across more than one teaching year, the Planned learning hours field only records the planned hours for that teaching year (from 1 August until the following 31 July).
203. Learners who are continuing on a study programme or learning aims from 2015 to 2016 must update the hours fields at the start of 2016 to 2017 with the planned hours for the new teaching year.

Examples

- *A learner starts an aim on 1 September 2016 with a planned end date of 1 April 2018. The Planned learning hours field for 2016 to 2017 will record the planned hours for the period 1 September 2016 until 31 July 2017. The Planned learning hours field for 2017 to 2018 will record the hours remaining from 1 August 2017 until 1 April 2018.*
- *A learner starts a learning aim on 1 September 2016 with a planned end date of 31 July 2017, and is planning to start a second aim on 1 December 2016. The Planned learning hours field records the total planned hours up to and including 31 July 2017 for both aims.*
- *A learner started a learning aim on 1 September 2015 with a planned end date of 14 July 2016. The learner did not finish the learning aim on the Learning planned end date and will continue in learning in the 2016 to 2017 year. The Planned hours fields must be completed in 2016 to 2017 with the remaining hours that are planned to be delivered in 2016 to 2017 to enable the learner to complete the learning aim. If the learner is EFA funded and the total planned hours for 2016 to 2017 is less than 540, then an employment status record must also be returned.*

204. If a learner has learning aims that are both EFA funded and SFA funded during a single teaching year then **only** the planned hours for the EFA funded learning are recorded in the Planned learning hours field. The Planned employability, enrichment and pastoral hours field is also completed.

205. If the learner progresses from an EFA study programme or traineeship onto an SFA funded aim or apprenticeship in year, then the hours fields must not be amended. Only the hours for the EFA funded aims must be returned.
206. If a learner has a mixture of apprenticeship and non-apprenticeship learning aims planned at the start of the teaching year (or start of learning) then only the planned hours for the non-apprenticeship learning aims are recorded in the Planned learning hours field.

9.3 Recording learner contact details

207. The following data is collected in the Learner Contact entity:

- Locator Type
- Contact Type
- Postcode prior to enrolment
- Current Address Lines 1-4
- Current Postcode
- Current Telephone
- Current Email

208. The diagram below shows the Learner Contact structure:

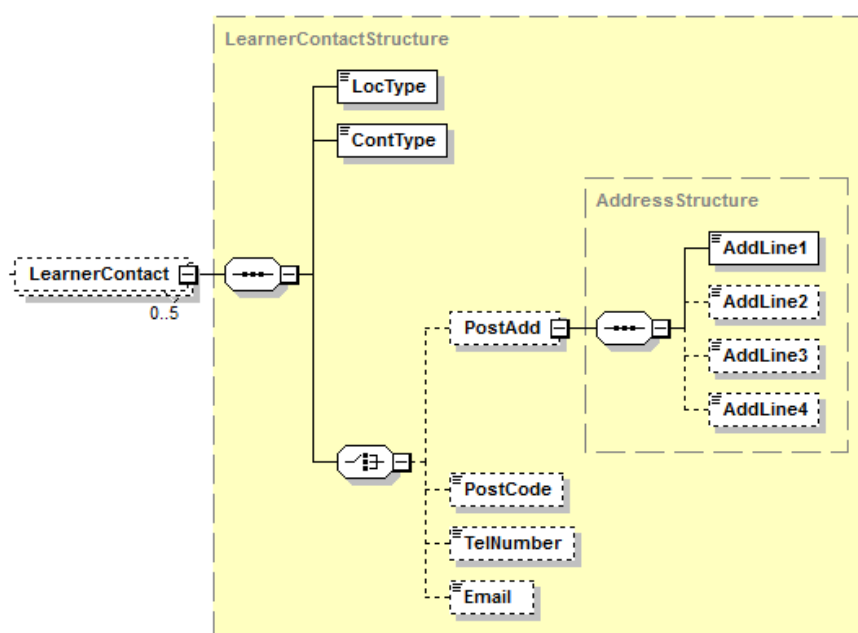

Figure 3: Learner Contact structure

209. The Locator Type field describes what type of contact data is being returned, for example; a postal address, an email address, a telephone number or a postcode.
210. The Contact Type field describes whether the locator details being returned are the Prior to enrolment or Current details. At present, only Postcode is returned for both prior to enrolment and current.

9.3.1 Postcode prior to enrolment

211. The Postcode prior to enrolment is completed when the learner first enrolls on a programme of learning with a provider. It should not be updated if the learner moves house during their programme of learning (which includes between teaching years if the programme of learning extends over more than one teaching year).
212. The Postcode prior to enrolment is used to calculate disadvantage funding and so providers must ensure that the Postcode prior to enrolment is not changed to influence funding for learning aims that are already in progress.
213. If the learner progresses to a new programme of learning, then the Postcode prior to enrolment should be updated, if applicable.

9.4 Recording learner contact preference

214. Data collected in the Learner Contact Preference entity is used to record any restrictions on the use of the learner's record to contact them about learning opportunities or for survey and research purposes. It also details any restrictions on what methods can be used to contact the learner, for example; telephone, email or post.
215. It is important that learner contact preferences are captured using the "opt out" questions illustrated in [Appendix F](#).
216. Please refer to Section 4 for information about the data protection requirements in regards to the collection of this data.

217. The contact preferences captured do not apply in the following two circumstances:

- Where learners may be contacted as part of a sampled survey to inform the effectiveness of the ESF 2014 to 2020 Programme. This only applies to ESF funded learners and Adult skills funded learners who could be used as match for the ESF Programme (including 16-18 apprenticeships)
- Where providers need to contact learners to collect Destination and Progression data. The only exception to this is where the Contact preference is recorded as 'Learner is not to be contacted' (RUI code 3, 4 or 5).

9.5 Recording learner learning difficulties, disabilities (LLDD) and health problems

218. Data collected in the LLDD and Health Problem entity is used to collect details about the nature of the learning difficulties, disabilities and health problems of the learner.
219. This entity contains two fields: 'LLDD and health problem category' and 'Primary LLDD and health problem'.
220. For 2016 to 2017, an additional category code has been added: Speech, Language and Communication Needs (code 17).
221. The LLDD and health problem data is completed on the basis of the learner's self-assessment. A learner may record as many categories as apply.
222. The Primary LLDD and health problem field must be returned against one of the LLDD and health problem records. The Primary LLDD and health problem field is used to indicate the most significant or primary learning difficulty, disability or health problem that impacts on the learner's education. This indicator must only be returned against one of the LLDD and health problem records for each learner.
223. The Primary LLDD and health problem field is not completed when the LLDD and health problem category is returned as code 98 'Prefer not to say' or code 99 'Not provided'.

Example

A learner has social and emotional difficulties and also dyslexia. Dyslexia has been identified as the primary difficulty.

Two LLDD and Health Problem records are returned; one recorded with a category of code 1 'Social and emotional difficulties', and the other with a category of code 12 'Dyslexia'.

The Primary LLDD and health problem indicator is returned against the record with category code 12 'Dyslexia'.

The XML for these LLDD and Health Problem records is as follows:

```
<LLDDandHealthProblem>
  <LLDDCat>1</LLDDCat>
</LLDDandHealthProblem>
<LLDDandHealthProblem>
  <LLDDCat>12</LLDDCat>
  <PrimaryLLDD>1</PrimaryLLDD>
</LLDDandHealthProblem>
```

9.6 Recording Learner Funding and Monitoring

224. Data collected in the Learner Funding and Monitoring entity is used to identify additional attributes of the learner to inform funding or for additional monitoring.

225. The Funding and Monitoring (FAM) type identifies the type of data to be collected and is recorded with an associated FAM code. Both a FAM type and FAM code are required for this data to be unique.

226. The *ILR Specification* gives further details on when FAM data should be returned.

227. There are twelve Funding and Monitoring types, as shown in the table below:

FAM Type	FAM Type Description	Definition
LDA	Learning difficulty assessment	To indicate if a learner has a Section 139A Learning Difficulty Assessment. Note LDAs cease as of 1 September 2016.
HNS	High needs students	To indicate if a local authority has paid element 3 'top-up' funding for an EFA funded student whose agreed support costs are greater than £6,000
EHC	Education Health Care Plan	To indicate if the learner has an Education Health Care Plan
DLA	Disabled students allowance	To indicate if the learner is in receipt of disabled students allowance
LSR	Learner support reason	Identifies categories of other learner support for the learner
SEN	Special educational needs	Identifies a learner with a learning difficulty or disability which calls for special educational provision to be made

NLM	National learner monitoring	To identify any additional monitoring characteristics required for the learner
EDF	Eligibility for EFA disadvantage funding	To indicate if the learner is eligible for EFA disadvantage funding
MCF	GCSE maths condition of funding	To indicate if the learner is exempt from or has met the GCSE maths condition of funding
ECF	GCSE English condition of funding	To indicate if the learner is exempt from or has met the GCSE English condition of funding
FME	Free meals eligibility	Learner eligibility for free meals
PPE	Pupil premium funding eligibility	Learner eligibility for Pupil Premium Funding

9.7 Recording employment status

228. Data about a learner's employment status is collected in the ILR to demonstrate how the FE sector is contributing to improving the employability of the learners. This data is also used to monitor funding eligibility and so care must be taken to ensure that employment status records are completed accurately.
229. An Employment status record must be created for all adult learners, apart from OLASS funded learners and those with only Community Learning funded learning aims. Employment status records are required for all apprenticeship and ESF funded learners of all ages.
230. EFA funded learners on part-time programmes of study (less than 540 hours in the teaching year) must have an Employment status record. You must also record the Employment intensity indicator (EII) Employment status monitoring type for these learners.
231. Data about a learner's employment status prior to enrolment must be collected in all cases when a learner first enrolls with a provider. There is no defined time period for "prior to enrolment", unless defined by the learner's programme. Providers are expected to use their judgement based on the individual learner's circumstances if there is any doubt as to what should be recorded.

Examples

If a 16 year old has left education in July and enrolled on a course the following September they would be classed as previously in education.

If a learner is employed, and has been on holiday or otherwise temporarily away from a job prior to starting a learning aim, they should be classed as being 'In paid employment'.

232. The Employer identifier field is not collected for an Employment status prior to enrolment, unless the learner is entering into **an apprenticeship** with **that** employer.
233. Refer to Section 12.1.1 for details and examples of recording employment status for apprentices.
234. **You should only send records that relate to a learner's current learning.** You must ensure that the 'Date employment status applies' of the earliest Employment status record is before the earliest learning aim start date (**from Learning start date, or Original learning start date if completed**) recorded for the learner.

235. You should not send historic employment records that have a 'Date employment status applies' that is earlier than the employment status record that applies **immediately** before the earliest learning aim start date for the learner. You must return all employment status records with a date subsequent to this.

9.7.1 Updating employment status

236. New employment status records should be added for a learner in the following circumstances:

- If there is a change in a learner's employment status or employment status monitoring (for example, a change in the learner's **employer or** benefit status) during their learning or at the start of a new learning aim or programme. **Where the only change since the previous employment status record is the length of employment (LOE) or length of unemployment (LOU), then a new employment status record does not need to be added.**
- For apprenticeships, if the learner was unemployed or employed with a different employer prior to starting their apprenticeship programme
- For apprenticeships, if the employer changes during the programme
- For EFA funded learners, at the start of each teaching year if the details have changed since the previous year.

237. Note that a learner may undertake several learning aims within a single learning agreement or plan, and there is no need to review or add a new employment record at the start of each new aim.

238. New validation rules introduced 2016 to 2017 prevent consecutive employment status records being returned where the data is duplicated. For example, records will fail validation where two employment status records have the same values for **Employment status, Employer identifier (including where the Employer identifier has not been returned), and Employment status monitoring types and codes, and consecutive dates in the 'Date employment status applies' field.**

9.7.2 Learner eligibility

239. Providers must ensure that the learner meets any employment related eligibility criteria for the learning aims being undertaken and that the learner's employment and benefit status prior to starting their learning is recorded accurately.

240. The SFA will use the employment status data to monitor funding eligibility for adult skills fully funded learning:

- Learners in receipt of JSA (BSI code 1) or ESA-WRAG (BSI code 2) are eligible for full funding.
- **Learners in receipt of Universal Credit (BSI code 4) are eligible for full funding where they are determined by Jobcentre Plus (JCP) as being in one of the following groups: All Work-Related Requirements Group, Work Preparation Group, or Work-Focused Interview Group.**
- Individuals in receipt of JSA, ESA-WRAG and **the Universal Credit groups stated above** can be employed for up to 16 hours per week and recorded with employment status code 10 and an Employment Intensity Indicator of EII code 2. Learners who are unemployed will normally be required to demonstrate an employment status of code 11 "Not in paid employment, looking for work and available to start work" as a condition of receiving that benefit. There may be some circumstances where an individual can be recorded with code 12 "Not in paid employment, not looking for work and/or not available to start work".

- In order to be eligible for full funding at the provider's discretion, learners in receipt of any other state benefits (BSI code 3) must be either unemployed and want to be employed, or earn either less than 16 times the National Minimum Wage a week or £330 a month and want to progress into more sustainable employment. Learners with an Employment intensity indicator (EII) of greater than 16 hours per week are ineligible. The provider must be satisfied that the learning is directly relevant to their employment prospects and the local labour market needs.

241. The following web page details the most common other state benefits:

<https://www.gov.uk/income-tax/taxfree-and-taxable-state-benefits>

9.7.3 Collecting employment status data

242. It is recommended that providers collect employment status data about learners via the use of a number of layered questions, similar to the approach taken for surveys. If possible, these questions should be asked in person during enrolment. The ordering of the questions is important, i.e. Q1 must be asked first.

243. Example of layered question approach:

- Q1) Did you do any paid work before joining this course, either as an employee or as self-employed? Yes/No
- Q2) You said you were not doing any paid work before this course – were you looking for paid work? Yes/No
- Q3) Which of the following types of benefit are you claiming?
Jobseekers Allowance
Employment Support Allowance (Work Related Activity Group)
Universal Credit
Any other state benefit (includes all state benefits not just those related to unemployment)?
- Q4) How long have you been out of work?
Either provide the bands on the ILR or let learner give a number and define bands later
- Q5) You said you were doing some paid work – in your main job, were you? An employee /Self-employed
- Q7) How many hours per week do you work?
Either provide the bands on the ILR or let learner give a number and define bands later
- Q8) For apprentices only: How long have you been in employment with your current employer prior to starting your apprenticeship?
Either provide the bands on the ILR or let learner give a number and define bands later
- Q9) Were you in full-time education before starting this course? Yes/No

Structure of the Employment status records

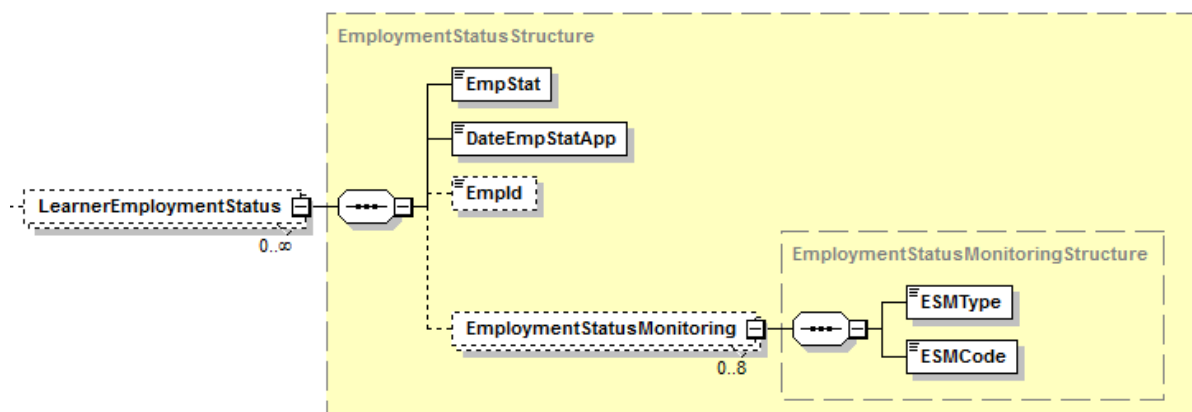

244. The Employment status and Date employment status applies fields must be completed on all employment status records.

Employment status

245. The Employment status field describes the learner's employment status and has the following categories:

Code	Description
10	In paid employment
11	Not in paid employment, looking for work and available to start work
12	Not in paid employment, not looking for work and/or not available to start work
98	Not known / not provided

246. Employment status is required for ESF match funding so you must only return an employment status of 'Not known/not provided' (code 99) in exceptional circumstances.

Date employment status applies

247. Each employment status record must have an associated Date employment status applies.

248. There can only be one record for any given date and therefore only one employment status for a learner on any given date.

Employer identifier

249. The Employer identifier must be recorded for every learner who is employed at the start of learning and is undertaking an apprenticeship or ESF funded provision.

250. If a learner is unemployed at the start of an apprenticeship programme and subsequently becomes employed, then a new record **must** be returned with the Employer identifier.

251. If a learner was employed with a different employer prior to starting their apprenticeship programme, then a new record must be returned with the Employer identifier of the new employer with whom they are undertaking the apprenticeship.

252. For learners recorded with a Funding and Monitoring type of WPL in 2015 to 2016, the Employer identifier can continue to be returned in 2016 to 2017.

Employment status monitoring

253. The Employment Status Monitoring fields should be completed with the relevant monitoring type where applicable.

254. For EFA funded learners, only the Employment intensity indicator must be completed. No other employment status monitoring is required for these learners.

255. There are seven Employment status monitoring types, the details of when you should return these are described in the table below.

256. For 2016 to 2017, the Employment status monitoring type Risk of NEET (RON) has been removed.

			Employment status				
			10	11	12	98	
Employment Status Monitoring Type	SEI	Self-employment indicator	√ If applicable	X	X	-	
	EII	Employment intensity indicator	√ Returned for all records	X	X	-	
	LOU	Length of unemployment	X	√	√	-	
	LOE	Length of employment	√ Returned for all apprentices	X	X	-	
	BSI	Benefit status indicator	If applicable				-
	PEI	Previous education indicator	If applicable				-
	SEM	Small employer	√ If applicable: apprenticeship standards only	X	X	-	

9.8 Recording learning aims: the Learning Delivery entity

257. The following data item has been added to the Learning delivery entity for 2016 to 2017:

- Apprenticeship standard code

258. The Learning Delivery entity contains information such as learning start and end date, funding information, and learning outcome. In addition, for certain types of programme (as listed in the Programme type field), a Learning Delivery record is returned to describe the programme being followed. This is known as the 'programme aim'. The programme aim contains information about the overall learning programme being followed and comprises a subset of data fields required for a learning aim.

Examples

- *Where a learner is studying three GCE A levels, there would be three Learning Delivery records*
- *Where a learner is studying a competency-based qualification and a functional skill, there would be two Learning Delivery records*
- *Where a learner is studying on an apprenticeship framework programme comprising of a competency-based qualification, three functional skills and a knowledge based qualification, there would be six Learning Delivery records: one programme aim and five component learning aims*
- *Where a learner is studying on a traineeship programme comprising work preparation, work placement, English and maths learning aims, there would be five learning aims: one programme aim and four component learning aims.*

259. The following entities, linked to the Learning Delivery entity, contain data that may not be required for all learners:

- Learning Delivery Funding and Monitoring – additional data to support funding and learning delivery monitoring
- Learning Delivery Work Placement – additional data about work placements/work experience learning aims
- Trailblazer Apprenticeship Financial Record – additional data to support funding for apprenticeship standards funded through the trailblazer funding model
- Learning Delivery Provider Specified Monitoring – additional provider data used as required and specified by the provider
- Learning Delivery HE – HE data fields

9.8.1 Recording programme aims

260. A programme aim must be recorded for the following programmes:

- Traineeships (see Section 13)
- Intermediate-level, Advanced-level, and Higher apprenticeship frameworks
- Apprenticeship standards

261. See the [apprenticeships](#) section of page 67 for details about recording apprenticeship programmes.

262. A programme aim is not recorded for an EFA funded study programme unless it is a traineeship.

263. The Aim type field distinguishes programme aims from other learning aims. Programme aims must be recorded with Aim type code 1.
264. The programme aim records the start date, planned end date, actual end date, and completion and outcome data relating to the overall programme. For apprenticeship standards, the Learning planned end date includes the training and end point assessment period.
265. Not all Learning Delivery fields need to be returned for a programme aim. See the individual programme sections and field collection requirement tables for details of which fields are required for the different programme types.

9.8.2 Recording non-regulated provision

266. *Appendix H of the ILR Specification* details how non-regulated provision should be recorded. The generic learning aim references are used to record non-regulated provision or in a small number of circumstances for regulated learning for which there is no other learning aim reference listed in the LARS database.
267. Please note:
- providers should only use non-regulated provision in areas already identified and agreed by the funding agencies as detailed in their published funding documentation.
 - the LARS database holds details of all learning aims but their funding eligibility is determined by the funding policies of the SFA and EFA.
268. The full set of generic learning aim codes can be found in the LARS database.
269. Providers should only use generic learning aim codes if there is not an appropriate regulated qualification learning aim available for the learner.
270. The generic learning aims have sequential numeric codes prefixed by the letter 'Z', these generic learning aim references are also known as class codes. Providers will need to search the LARS database using the Sector subject area, Level and, where applicable, funding band to identify the correct code to use.
- For example: Z0001543 – Non regulated SFA formula funded provision, Entry Level, Preparation for Work, 101 to 196 hrs, PW A
271. You can search for class codes using the [Learning Aims search](#) function on the Hub; the Category search filter (see below) can be found within the 'Additional filters' section on the Learning Aims search page.

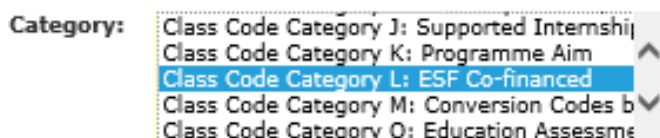

The example in the image above shows the Category L class code selected. You can select multiple categories by holding the Ctrl key and selecting all applicable categories.

To search all class codes, select the 'All Class Code Categories' option in the Category search filter.

272. For learning aims funded through the Adult skills funding model, if the actual hours delivered for a learning aim change from the planned hours band recorded for the Learning aim, then the ILR is not updated.

Example

A learner undertaking an entry level course in work skills with planned guided learning hours of 150hrs, is recorded using the following aim Z0001543 – Non-regulated SFA formula funded provision, Entry Level, Preparation for Work, 101 to 196 hrs.

If, after the qualifying start period, the guided learning hours are increased to 200 hrs for this learning aim due to revised delivery arrangements, then the learning aim is not updated or amended.

9.8.3 Searching for learning aims

273. The LARS database holds information about learning aims and their validity, as well as funding data where applicable. It is maintained by the SFA. Updates to the database are made regularly. It can be searched online using the Learning Aims Search facility on the Hub <https://hub.imservices.org.uk/Learning%20Aims/Pages/default.aspx> or downloaded.
274. Each learning aim on the database has a reference code that is used to record it in the Learning aim reference field on the ILR. The database holds all the learning aim specific information that providers will need. Further details can be found on the GOV.UK website at: <https://www.gov.uk/government/publications/individualised-learner-record-ilr-sources-of-data>
275. If a learning aim is not included on the database, you should request a new learning aim code from the SFA as soon as the learner is enrolled onto the learning aim. If you do not request codes until after the year is completed, after July 2017, you may not be able to make returns on time because the software may not recognise the codes. A form is available on the GOV.UK website to request a new HE learning aim at: <https://www.gov.uk/government/publications/individualised-learner-record-ilr-sources-of-data>
276. This form is not required to request the addition of a unit into the LARS database for non-funded learning; providers should raise a call with the Service Desk and give them the Ofqual reference number of the unit required.
277. Providers can record a learning aim on the ILR once it has been accredited by the awarding organisation and approved for funding.
278. The validation rules will only allow aims with start dates after the funding validity start date and before the last date for new starts in the LARS database to be recorded.
279. Providers should ensure that the Learning start and Learning planned end dates for the learning aim are within the validity start and end dates in the LARS database.

9.8.4 Recording proxy learning aims

280. If there is a delay with the publication of information in the LARS database, then providers can temporarily enter the nearest equivalent aim (in terms of type of provision and funding rate) into the Learning aim reference field.
281. Code LDM118 should be recorded in the [Learning Delivery Funding and Monitoring](#) fields to indicate that the learning aim reference recorded is being used as a proxy for the actual learning aim that is being undertaken.
282. Once the actual learning aim reference is published, providers must update the code recorded in the Learning aim reference field and remove code LDM118 from the Learning Delivery Funding and Monitoring fields.
283. In all cases, the proxy aim details must be removed and the actual aim details recorded before the end of the teaching year or before the learner completes or withdraws from the learning aim, otherwise the data will be rejected.

9.8.5 Funding adjustment for prior learning and Other funding adjustment

284. The Funding adjustment for prior learning field should be completed with the proportion of the learning aim that is still to be delivered if the learner is not undertaking the full scope of the learning aim because of prior learning. This can be because of a break in learning, a transfer from another provider, or because of prior learning when they join as a new learner on a new learning aim. If the provider is delivering all of the learning for the aim and no adjustment to funding is required, the field is not returned.
285. If the learner is returning from a break in learning or has transferred provider, as identified in the ILR as a 'restart', then the adjustment is based upon the time they have been in learning as a proportion of the time originally planned for this learning aim. This is based upon the percentage difference between the original planned duration and the proportion of that time that they have already been in learning. The funding adjustment is applied to the monthly funding instalments but not to the achievement element.
286. For a learner who starts a learning aim with prior learning and is not a restart, in other words they do not need to undertake the full scope of the learning, you must record the percentage of learning left to undertake. This calculation is at your discretion and you must retain evidence of the calculation for audit. It could, for example, be based upon the percentage of credits left to deliver, time left to deliver or learning left to deliver. The funding adjustment is applied to the monthly funding instalments and to the achievement element.
287. The Other funding adjustment field must only be completed if requested by the SFA with the amount required to increase or decrease the funding for the learning aim, for reasons other than prior learning. If no adjustment to the funding of the learning aim is required, then this field must not be returned. The SFA will inform providers of the factor to be used in this field if required.
288. For SFA funded A levels, if a learner undertakes both an AS and an A level in the same subject, the provider will need to record a funding adjustment on the ILR for the A level, to take into account the prior learning completed for the AS learning aim.

9.8.6 Subcontracted or partner UKPRN

289. The Subcontracted or partner UKPRN field is completed by the lead provider where any part of the aim is subcontracted. Where the individual parts of the aim are subcontracted to numerous providers, the UKPRN for the provider delivering the greatest proportion of the aim should be recorded in this field.
290. If the subcontracting partner changes, then this field should be updated with the new subcontractor's UKPRN. No other changes to the record are required. Do not record this as an aim transfer.
291. If the subcontractor is no longer delivering the aim, then this aim must be closed on the subcontractor's ILR return with an appropriate Withdrawal reason.
292. FE colleges who are delivering subcontracted aims on behalf of another provider should include these aims as non-funded learning (Funding model = 99) on their ILR and do not complete the Subcontracted or partner UKPRN field.

9.8.7 Additional delivery hours

293. This field records the additional guided learning hours (GLH) delivered for Adult skills funded and ESF funded ESOL units or qualifications where a learner needs additional learning to that funded through the applicable matrix rate. If the learning aim was started in 2015 to 2016, we will use the matrix in place at that time to calculate additional funding. For learning aims that start in 2016 to 2017, we will use the Single Activity Matrix (SAM) to calculate additional funding.
294. The additional hours are determined by calculating the difference between the total guided learning hours (GLH) that are planned for the delivery of the unit or qualification and the maximum value for the GLH range that corresponds to the matrix rate for that unit or qualification (see the [Funding rates and formula 2016 to 2017](#)).
295. The additional delivery hours will generate funding by matching the value of the additional hours to the matrix. The matrix value for that funding band will be added to the original rate of the aim to give an overall rate. All ESOL aims are assumed to have the base programme weighting (A) for the calculation of the additional amount.
296. The Additional delivery hours field may be used for approved ESOL units or qualifications and must not be used for non-regulated ESOL or any other ESOL qualifications.
297. For ESOL learning aims which start before 1 August 2015, the Additional delivery hours must not be returned. The previous interim arrangements detailed in the [ESOL guidance](#) continue to apply for these aims, this may include recording additional non-regulated learning aims.

Example

The learning aim being delivered is an Award in ESOL Skills for Life. This has a matrix rate of £600. The aim is being delivered in a total of 150 guided learning hours.

The matrix rate of £600 maps to the activity type 'Medium provision (3)':

Funding band – hours	Activity type	Programme weighting (PW)				
		A – Base (unweighted)	B – Low	C – Medium	D – High	E or G* (specialist)
Up to 2	Very small provision (1)	£14	£16	£18	£22	£24
3 to 4	Very small provision (2)	£21	£24	£27	£34	£36
5 to 6	Very small provision (3)	£35	£39	£46	£56	£60
7 to 12	Small provision (1)	£50	£56	£65	£80	£86
13 to 20	Small provision (2)	£100	£112	£130	£160	£172
21 to 44	Small provision (3)	£150	£168	£195	£240	£258
45 to 68	Medium provision (1)	£300	£336	£390	£480	£516
69 to 92	Medium provision (2)	£450	£504	£585	£720	£774
93 to 100	Medium provision (3)	£600	£672	£780	£960	£1,032
101 to 196	Large provision (1)	£724	£811	£941	£1,159	£1,246

The maximum GLH for this band is 100 hours. The difference between the total GLH being delivered for the qualification and the maximum GLH for the aim's funding band is $150 - 100 = 50$ GLH.

The value of 50 is therefore recorded in the Additional delivery hours field and will generate an additional £300 for the delivery of this learning aim (based on the funding band for 50 hours in the funding rates document)

The total funding for this aim is: $£600 + £300 = £900$

9.9 Recording Learning Delivery Funding and Monitoring

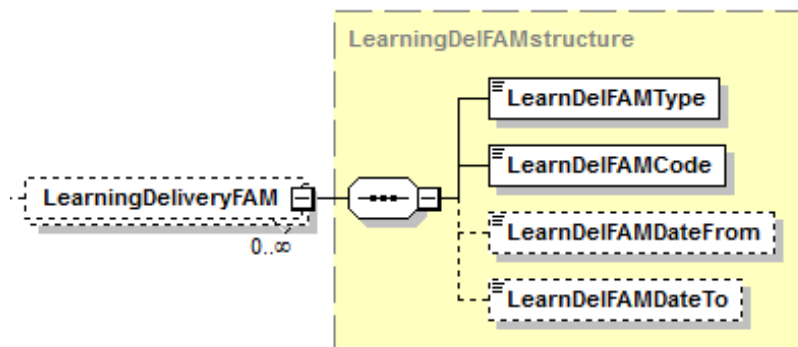

298. For 2016 to 2017, the following types have been removed from the Learning Delivery Funding and Monitoring fields:

- Workplace learning indicator (WPL)
- Trailblazer apprenticeship standard (TBS)

299. Refer to Section 8 for details about how to migrate data for learners continuing from 2015 to 2016 into 2016 to 2017 who were recorded with the Workplace learning indicator, or are on apprenticeship standard programme.

300. The descriptions for ADL and ALB have been revised for 2016 to 2017.

301. Data collected in the Learning Delivery Funding and Monitoring entity is used to identify additional attributes of the learning delivery, to inform funding, or for additional monitoring.

302. The Funding and Monitoring (FAM) type identifies the type of data to be collected and is recorded with an associated FAM code. Both a FAM type and FAM code are required for this data to be unique.

303. The Learning Delivery Funding and Monitoring entity is only required if any of the FAM type characteristics apply to that learning aim, please refer to the information on individual FAM types in the ILR specification for collection requirements.

304. There are sixteen Funding and Monitoring types as shown in the table below:

FAM Type	FAM Type Description	Definition
SOF	Source of funding	The organisation or source from which funding has been received directly for this learning aim in this teaching year
FFI	Full or co-funding Indicator	Indicates whether the learning aim is fully funded or co-funded by the SFA
EEF	Eligibility for enhanced apprenticeship funding	To indicate eligibility for enhanced apprenticeship funding
RES	Restart indicator	To identify whether the learner has restarted the learning aim
LSF	Learning support funding	To identify whether the learner requires learning support funding for this learning aim
ADL	Advanced Learner Loans indicator	To identify whether the learning aim is financed by an Advanced Learner Loan
ALB	Advanced Learner Loans Bursary fund	To identify whether the learner is in receipt of an Advanced Learner Loans Bursary funding for this aim

FAM Type	FAM Type Description	Definition
ASL	Community Learning provision type	Identifies the type of Community Learning activity being undertaken
FLN	Family English, Maths and Language	Identifies regulated Family English, Maths and Language courses that are delivered through the Adult skills funding model
LDM	Learning delivery monitoring	Indicates participation in programmes or initiatives
SPP	Special projects and pilots	Indicates participation in pilots or special projects
NSA	National Skills Academy indicator	To identify delivery of learning by a National Skills Academy
WPP	Work programme participation	To identify learning aims that are delivered as part of a DWP Work Programme
POD	Percentage of online delivery	The proportion of the curriculum design (scheme of work) delivered by computer mediated activity rather than by a lecturer.
HEM	HE monitoring	The HE monitoring codes should be used if they apply for aims where Learning Delivery HE data is returned
HHS	Household situation	Information about the household situation of the learner

305. *The ILR Specification* gives further details on when FAM data should be returned.

Example

- A learner has been recruited through the Diversity in apprenticeships initiative, they are fully funded and undertaking an apprenticeship framework programme in Construction with learning delivered at a National Skills Academy.

The following FAM record would be returned on the programme and component aims:

1. Source of funding record as SOF105
2. Full or co-funding indicator record as FFI1

The following FAM records would be returned on the programme aim only:

1. Learning delivery monitoring record as LDM123
2. National Skills Academy record as NSA4

Example

- A learner is funded through Former Community Learning and undertaking Wider Family Learning. The following FAM records would be returned:

1. Source of funding record as SOF105
2. Community Learning provision type record as ASL4

Restart indicator

306. This must be used to indicate that the learner has restarted a learning aim or apprenticeship programme. The Restart indicator should only be used if the learner is returning to a learning aim they have previously started on, e.g. after a break in learning or if the learner has transferred from studying the same learning aim with another provider. It must not be used where the learner has transferred to a different learning aim or programme with either the same or a different provider.

307. If the learner has restarted the entire apprenticeship programme then the Restart indicator must be recorded against the programme aim and all the learning aims within the programme. If only one of the aims within the programme has been restarted then the Restart indicator is only recorded against that aim.

308. For learners who have had a break in learning from 1 August 2013, providers should record the Original learning start date in addition to the Restart indicator.

Learning support funding

309. Learning Support is provided to help providers to work flexibly and provide support activity to meet the learning needs of learners with an identified learning difficulty and/or disability. This will enable these learners to achieve their learning goal. Learning Support also provides funding to meet the cost of reasonable adjustments as set out in the Equality Act 2010.

310. The Learning Support Funding (LSF) FAM type should be recorded against one of the learning aims for learners who need learning support funding. For apprenticeship and traineeship learners this is recorded on the programme aim record only. For traineeship learners, once the Programme aim has ended the LSF is recorded against one of the remaining component aims if applicable: see paragraph 572 for further details.

311. The LSF FAM type is used by all types of provider for learning aims funded through the Adult skills funding model or apprenticeship standards (including FE colleges, local authorities and private training providers) and should be recorded for all learners who require learning support funding.

Date applies from / Date applies to

312. The Date applies from and Date applies to fields must be completed when a Learning Delivery FAM type of Learning support funding (LSF) or Advanced Learner Loans Bursary Fund (ALB) is recorded. These date fields indicate when the funding is effective from and effective to.

313. If the status changes in year, new FAM records should be added with new corresponding dates without the need to close the learning aim and open a new one.

Examples

- A learner has a learning aim start date of 1 September 2016 and the learner is in receipt of Learning support funding for two months. A Learning Delivery FAM record will be recorded with a FAM type of LSF, the Date applies from will be recorded as 1 September 2016, and the Date applies to will be 31 October 2016.
- If the learner received Learning support funding a month later, and is in receipt of the funding for three months, a second Learning Delivery FAM record of type LSF will be recorded with a Date applies from of 1 December 2016, and a Date applies to of 28 February 2017.

314. If the Learning support funding or Advanced Learner Loans Bursary funding is required for the entire duration of the learning aim, the Date applies to field should be completed with the Learning planned end date. If this changes and the Learning support or Advanced Learner Loans Bursary funding is no longer required until the Learning planned end date, then the Date applies to field should be updated with the new earlier date.

315. If the period of time recorded on the ILR is less than one calendar month then providers will need to claim the Learning support funding through the EAS as detailed in the [Funding Rules](#).

Family English, Maths and Language

316. The purpose for all Family English, Maths and Language (FEML) learning aims is to support children's learning and improve their home environment. The full requirements for FEML learning aims can be found in the *ILR Specification 2016 to 2017*.
317. The Learning Delivery FAM type Family English, Maths and Language (FLN) should be completed by providers only to record Family English, Maths and Language (FEML) learning aims that are delivered through the Adult skills funding model (Funding model = 35).
318. Where FEML learning aims are funded through the Community Learning funding model (Funding model = 10), providers must record this using the existing Community Learning provision type (ASL) FAM type.

Percentage of online delivery

319. The percentage of online delivery recorded in this field is the proportion of the curriculum design (scheme of work) delivered by computer mediated activity rather than by a lecturer. This is activity which replaces face to face lecturing time and not time spent on researching information on the web.
320. This field must be returned for all non-apprenticeship learning aims funded through the Adult skills funding model that start on or after 1 August 2014.
321. The percentage of online delivery recorded in the ILR should be what is planned as part of the curriculum design of the scheme of work for each learning aim. Providers do not need to track actual time spent online by individual learners. It is teaching and learning that is delivered through an online medium and replaces what would otherwise be delivered by a lecturer.
322. This data will be used to inform future policy and funding decisions. It will not be used directly for funding in 2016 to 2017 and will not form part of a provider's audit. Consequently there are no specific evidence requirements that providers need to meet.
323. The following are examples of online learning:
- Learning materials that the learner accesses on a college virtual learning environment such as Moodle
 - Video demonstrations or PowerPoint presentations accessed outside the classroom
 - Structured learning packages that are not facilitated by a lecturer.
324. The following are examples of activities that do not constitute online learning and should not be included in calculation of the Percentage of online delivery:
- A video of a practical demonstration that is shown in the classroom with the lecturer present
 - Work undertaken on a computer with a lecturer present
 - An online webinar delivered by a lecturer
 - Homework assessments that are undertaken online
 - Email/telephone or online tutorials or feedback discussions

9.9.1 Recording Source of funding

325. This guidance sets out how the Source of funding in the [Learning Delivery Funding and Monitoring](#) fields should be completed in the ILR.
326. This is particularly important for learners who turn 19 during their course of study or for learners aged 19 to 24 who have a Learning difficulty assessment (LDA) or Education Health Care Plan (EHC).

Learners who turn 19 during their learning aim or programme

327. For 16 to 18 apprenticeships, no change to the learner's data is required if the learner turns 19 during the programme. The learner should continue to be recorded using code 35 in the Funding model field and with the SFA as the Source of funding (code 105). A Learning Delivery FAM record does not need to be returned for Eligibility for enhanced apprenticeship funding (EEF).
328. If the learner was funded using the 16-19 EFA funding model (code 25) prior to their 19th birthday then they will continue to be funded using this funding model until they complete their learning aim. The Funding model field remains recorded with code 25 and should not be changed.
329. If the learner is still in learning for the following teaching year after they turn 19 then the source of funding will need to be changed to indicate that the funding will come from the SFA for providers who have an existing funding agreement with the SFA (refer to the SFA funding rules). The Source of funding Learning Delivery FAM record must be amended to code 105 (SFA).
330. Learners who turn 19 during the month of August will also be funded by the SFA for that year (1 August 2016 to 31 July 2017) and must update the Source of funding to code 105 (SFA).
331. The exception to this is for sixth form colleges and academies where learners who turn 19 during their course of study will continue to be funded by the EFA for the duration of their learning.

Learners aged 19-24 who have a Learning Difficulty assessment (LDA) or Education Health Care Plan (EHC)

332. All learners aged 19-24 who have an **Learning difficulty assessment (LDA) or Education Health Care Plan (EHC)** must be recorded using Funding model code 25 and Source of funding code 107, unless they are on an apprenticeship programme; see paragraph 337 and 338 below for details of how to record 19-24 year old apprentices who have an EHC plan or LDA.
333. If any of these learners are also defined as high needs students, then this must be recorded in the Learner FAM fields using the High Needs Student (HNS) FAM Type.
334. **From 1 September 2016, LDAs cease to have any legal effect. Young people aged 19-24 are only eligible for EFA funding where the young person has an Education, Health and Care (EHC) plan in place. Therefore, 19-24 year old students without an EHC plan should be coded as SFA funded unless they are a 19+ continuing student in a sixth form college or academy.**
335. Once the learner becomes 25, the Source of Funding code 105 should be recorded from the start of the next teaching year. The Source of funding must not be changed in year. The funding model for these learners is unchanged – code 25.
336. The table below outlines how the Funding model and Source of funding fields should be completed for different combinations of age at start, current age and whether or not the learner has an LDA or EHC.

Age on 31 August of teaching year in which learning started	Age on 31 August of current teaching year	LDA/EHC recorded		Funding model	Source of funding (SOF)
16-18	16-18	yes or no	record with	25	EFA (SOF107)
16-18	19+	no	record with	25	EFA (SOF107) for 6 th form colleges/academies SFA (SOF105) for all other types of providers
16-18	19-24	yes	record with	25	EFA (SOF107)
16-18	25+	yes or no	record with	25	SFA (SOF105)
19+	19+	no	record with	35	SFA (SOF105)
19-24	19-24	yes EHC	record with	25	EFA (SOF107)
19-24	19-24	LDA*	record with	35	SFA (SOF105)
19-24	25+	yes	record with	25	SFA (SOF105)
For apprentices, see below					
*For these learners, if they had an LDA but do not have an EHC plan, then remove the LDA and record as Source of funding SOF105					

Learners aged 19-24 who have an Learning difficulty assessment (LDA) or Education Health Care (EHC) plan on an apprenticeship **framework** programme

337. Apprenticeship **frameworks** are always recorded using Funding model code 35 and Source of Funding code 105. This applies to 16-18 apprenticeships, and to 19-24 apprenticeships where the learner has an EHC plan or LDA.

338. Where apprentices are aged 19-24 and have an EHC plan or LDA, the following Learning Delivery FAM records must be returned:

- Eligibility for enhanced apprenticeship funding (EEF). This should be returned with code 2, "Entitlement to 16-18 apprenticeship funding, where the learner is 19 or over".
- Full or co-funding indicator (FFI). This should be returned with code 1, "Fully funded learning aim", for Adult Skills funded apprenticeship programmes only.

9.10 Recording Work Placements

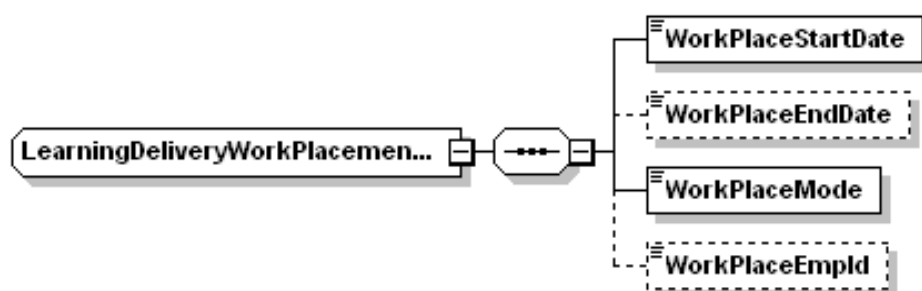

339. The Learning Delivery Work Placement entity is used to collect additional data about individual work experience placements that are being undertaken by a learner as part of a traineeship, Supported Internship or 16-19 study programme. See the [EFA study programmes](#) section on page 92 for details of recording work experience for EFA funded study programmes and the [Traineeships](#) section on page 84 for details of work experience within a traineeship.

340. This entity is not required for ESF work placements: work placement records do not need to be sent for ESF funded work placements.

341. Each work experience learning aim must have one or more work placement records associated with it. If a learner undertakes multiple work placements during their traineeship or study programme then separate work placement records will be recorded for each placement.

342. Work experience learning aims are recorded using one of the non-regulated learning aims listed in [Appendix H of the ILR Specification](#).

343. The Learning Delivery Work Placement entity has four fields:

Work placement start date

- This is the start date of the individual work placement. This must be a valid date on or after the start date of the learning aim.

Work placement end date

- This is the actual end date of the individual work placement and must be a valid date on or before the actual end date of the learning aim. This field should record the actual end date of the work placement once the placement has finished.

Work placement mode

- This describes the type of work placement being undertaken. An external work placement is time spent with an external employer, external to the learning environment and at an external site.
- A simulated environment in an education institution, such as a college restaurant run by an external organisation or experience in a college-based crèche that is a commercial enterprise, do not count as an external work placements and should be recorded as internal.
- Both internal and external work placements should be recorded on the ILR.

Work placement employer identifier

- This field must be recorded for all learners undertaking a work experience placement as part of a traineeship or Supported Internship. It is not required for work placements that are part of other 16-19 study programmes.

- This field must contain a valid employer number from the Employer Data Service (EDS). The EDS can be found at: <https://www.edrs.sfa.bis.gov.uk>. To obtain a new employer number, contact the EDS help desk on either 01242 545 346 or by emailing helpdesk@edrs.sfa.bis.gov.uk.

9.11 Recording Higher Education (HE) data

344. The ILR contains two HE datasets: the Learner HE entity and the Learning Delivery HE entity.

345. These datasets are collected for learners and learning aims that meet the following criteria where the collection requirements for the field apply:

For all providers

- Learning aims that are HEFCE funded, as indicated in the [Learning Delivery Funding and Monitoring](#) fields using code SOF1.

For grant funded provision (FE colleges and other grant funded providers)

- Learning aims that are level 4 or above in the LARS database and are funded by the EFA funding model (FundModel = 25); or are funded by the Adult skills funding model (FundModel = 35) and are not part of an apprenticeship programme; or are not funded by the EFA or SFA (FundModel = 99).
- Learning aims that are identified as prescribed HE in the LARS database (using the field EngIPrscID field) and are part of a higher apprenticeship programme (ProgType = 20-23, 25)*

* HEIs do not need to complete the Learner HE and Learning Delivery HE datasets on the ILR for higher and degree apprenticeships as this data will be included on your HESA return. See the [Data Requirements for Higher Education Institutions \(HEIs\)](#) for further details.

For contract funded provision (contract funded training providers and all apprenticeships started from 1 May 2017)

- Learning aims that are identified as prescribed HE in the LARS database (using the EngIPrscID field).

346. For learners with apprenticeship learning aims **that are not prescribed HE**, Community Learning and ESF funded learning aims, HE data is not returned.

347. HE data is requested by HEFCE and the Higher Education Statistics Agency (HESA).

348. The Learner HE and Learning Delivery HE fields should be completed as accurately as possible, and the use of default values should be avoided. Returning values such as 'not known' or 'not in HEIFES population' may adversely affect HEFCE funding and should only be used where appropriate.

349. In addition to the Learning Delivery HE fields, providers may also need to complete the HE monitoring data in the Learning Delivery Funding and Monitoring entity.

350. The Learner HE entity also contains the Learner HE Financial Support entity. The Learner HE Financial Support entity is completed annually. At the start of each academic year, any records relating to the previous academic year should be removed and are not returned.

Structure of the Learner HE entity

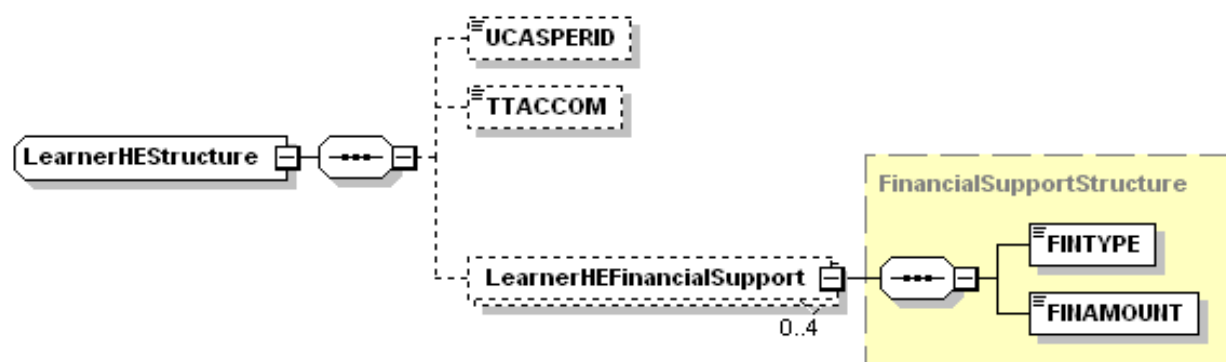

9.11.1 Recording Learner HE Financial Support

351. The Learner HE Financial Support entity collects details of the financial support received by the student for the year. This data will be used to understand the role that bursaries and other in-kind support play in determining the choice of where students study and the impact this has on their likelihood of continuing studies.

352. There are four financial types which can be collected. Each type can only be recorded once but the corresponding financial amounts are updated during the year.

353. Each Financial support type and Financial support amount pair should be recorded once per applicable Financial support type. Where the student is in receipt of multiple forms of a Financial support type (for example, two forms of a cash support) these amounts should be summed and recorded under a single occurrence of the appropriate Financial support type.

Examples

- A HE learner is in receipt of scholarship and receives a payment on the 15 September 2016 for £200. A Financial support type of Cash is recorded on the ILR with a corresponding Financial support amount of £200.
- The same learner during the year is in receipt of another scholarship payment of £400 and also in receipt of an accommodation discount of £300. A Financial support type of Accommodation discount is recorded on the ILR with a corresponding Financial support amount of £300 and as there already is a Financial support type of Cash on the ILR the new payment of £400 is added to the existing £200, therefore the Financial support type for Cash will have a value of £600.

Section 10 : Recording Learner Destination and Progression

354. The Learner Destination and Progression entity records the destination or progression outcomes for a learner when they have completed or withdrawn from the activities on their original learning agreement or plan. Destination and Progression outcomes for a learner include gaining employment or going onto further study. These outcomes will usually be reported after a learner has completed a programme of learning.
355. Data about a learner's destination and progression following the end of learning is collected in the ILR to demonstrate how the FE sector is contributing to the future success of learners.
356. Destination and Progression data is required for all learners except Community Learning and non-funded learners. See the *ILR specification* for full details of the collection requirements.
357. The Learner Destination and Progression entity is not part of the Learner entity, it has been designed to be a standalone dataset which can either be returned in the same ILR file as the Learner and Learning delivery records for the learner or can be returned on its own in the following teaching year.
358. The Learner reference number and Unique Learner Number (ULN) are included to enable data from this dataset to be matched to Learner and Learning delivery data for reporting purposes.

The Learner Destination and Progression record structure is illustrated below:

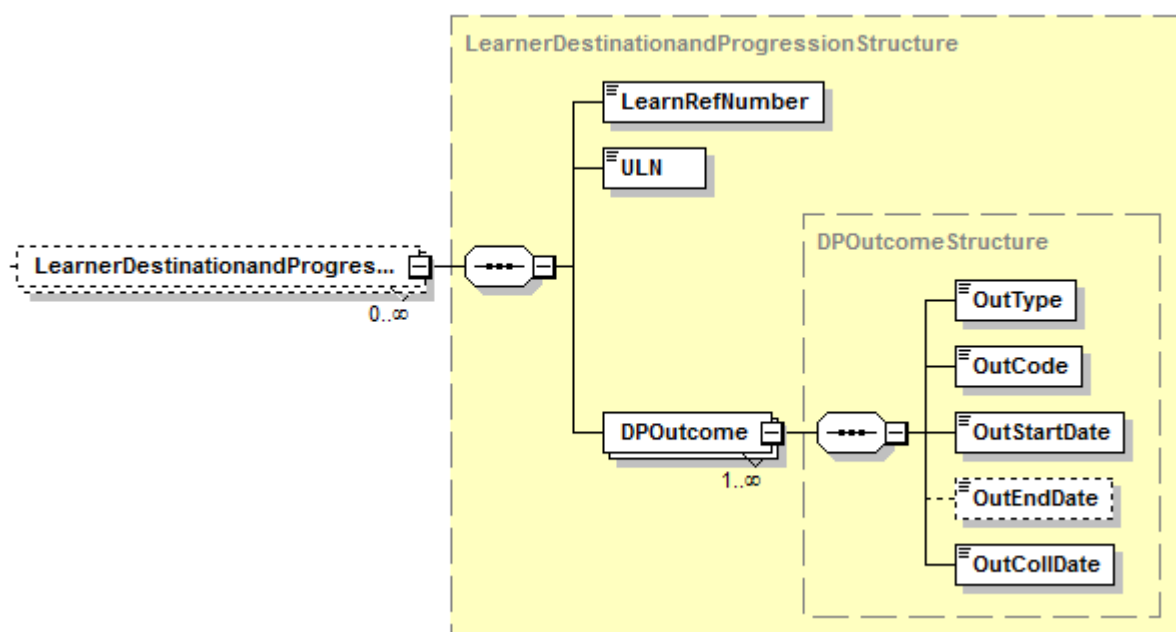

359. As with other Learner and Learning Delivery records, providers must continue to include Destination and Progression records in each ILR file that they send for the teaching year, in line with the ILR collection timetable.

10.1 When to collect and return destination and progression data

360. This data can be returned either in the year that the learner completes or leaves their learning aim/programme of learning, or in the following teaching year. If the learner is no longer in learning with the provider in the following year then the Destination and Progression data would be the only entity returned for that learner.

361. The 2016 to 2017 ILR returns should include all Learner Destination and Progression records where the collection date is between 1 August 2016 and 31 July 2017. See Section 13 for additional guidance for learners who complete a traineeship programme and Section 15 additional guidance for ESF funded learners.
362. Destination and Progression data should be returned for learners who remain with a provider to continue with further study as well as those who leave.
- If the learner is remaining with the provider to progress to a new programme of learning, then a Destination and Progression record should be reported as soon as the learner starts their next programme of learning
 - For learners who leave the provider, refer to the ILR Specification for full details of when the destination must be collected and recorded.
363. Data about a learner's destination and/or progression can continue to be recorded until the end of the teaching year following the year in which learning ended.
364. If a Destination record of "Apprenticeship" is recorded, an outcome record of employment does not also need to be added.
365. For Adult skills job outcome payments, the Employment outcome must be recorded in the Learning Delivery entity. The data recorded in the Employment outcome field should be consistent with the information recorded in the Destination and Progression entity.
366. Refer to the SFA's Funding Rules for the requirements for funding payments and evidence required to support these.
367. Where the learner was employed prior to learning and remains employed with the same employer following learning, or where the learner was unemployed prior to learning and remains unemployed following learning, then the Outcome start date should be recorded as the day after the Learning actual end date.

10.2 Updating destination and progression records

368. If a provider has already recorded a destination or progression outcome that they wish to update, for example, if the learner is confirmed as still being in a job at a later date, then the original record can be updated by amending the collection date. A new record with the same outcome type and code does not need to be added.
369. For each Learner Destination and Progression record the following fields must be returned:
- Outcome type
 - Outcome code
 - Outcome start date
 - Outcome end date
 - Outcome collection date
370. The Outcome type identifies the type of destination or progression outcome being recorded and is returned with an associated Outcome code. Both an Outcome type and Outcome code are required for the record to be unique.
371. There is no limit to the number of Destination and Progression records that can be returned for each learner. More than one record can be recorded with the same Outcome start date, although they must have different outcome type/code combinations.

Example

- *An unemployed SFA funded learner finishes all their aims in March 2017 and progresses into full-time employment, starting work on 12 June 2017. The provider contacted the learner on 1 July 2017 to find out this information.*

A Destination and Progression record should be sent for this learner. The record will contain the Outcome type of 'In paid employment' (EMP) with an Outcome code of 1 ('In paid employment for 16 hours or more per week'). The Outcome start date will record the date the employment began (12 June 2017), the Outcome end date is not returned as they are still in employment. The Outcome collection date is mandatory: this records the date on which the provider received the information of the learner's Destination and Progression (1 July 2017).

Example

- *A learner completes a traineeship on 1 September 2016 and progresses onto an apprenticeship with the same provider on 14 November 2016.*

In addition to the Learner and Learning Delivery records, the provider must return a Learner Destination and Progression record with an Outcome type of 'Education' (EDU) and an Outcome code of 'Apprenticeship' (code 2). The Outcome start date is the date the apprenticeship programme started, 14 November 2016. The Outcome end date is not returned as they are still doing the apprenticeship.

As the learner is progressing into an apprenticeship there is no need to record an additional Destination and Progression record for the learner entering paid employment.

Example

- *A 16-19 year old learner finishes a study programme on 20 March 2017 and progresses into full-time employment. The provider must return a Learner Destination and Progression record with the Outcome type of 'In paid employment' (EMP) and Outcome code of 'In paid employment for 16 hours or more per week' (code 1). The employment start date should be recorded in the Outcome start date field. The date the outcome data was collected by the provider must also be returned.*

On 4 May 2017 the learner enrolls back with the provider onto a further full-time programme of study having left employment. The provider must update the existing progression and destination record with an Outcome end date (the date they left employment) and update the existing Outcome collection date with the new date they received the updated information.

In addition to this, a new Destination and Progression record will need to be returned with the Outcome type of 'Education' (EDU) and Outcome code of 'Other FE (Full-time)' (code 4), and the corresponding Outcome start date and Outcome collection date fields.

Section 11 : Recording learner changes

372. The ILR records details about the learner, the learner's programme (if applicable), and the learning aims they are studying. It is possible that the information recorded in the ILR will change, as a result of either a change in circumstances of the learner, or a change to the learning aims they are studying. The main reasons for changing an ILR record are:

- correcting errors
- changes to a learner's details
- changes in a learner's programme or learning aim.

373. Guidance about how to record changes that only apply to specific programmes, for example recording an apprentice transferring from one framework to another, can be found within the guidance section for that programme. See Section 12 for apprenticeship programmes and Section 13 for traineeship programmes.

11.1 Correcting errors

374. The correction of data entry errors in ILR data can usually be made as soon as they are found, but only within the current teaching year. Any changes that are made outside of the funding qualifying period must be due to administrative errors only and not due to a learner changing courses. Contact the Service Desk on 0370 2670001 or <https://www.gov.uk/government/publications/sfa-data-services-help-and-support> if you need advice on making a correction.

11.2 Correcting data errors after 2015 to 2016 hard close

375. If data is found to be incorrect after hard close (R14) of the previous year and the data is incorrect due to an administrative error, then the data should be corrected **and continue to be returned in 2016 to 2017**.

376. Various scenarios of incorrect data are outlined below, and the process for correcting data in each of these situations is described.

377. Please note that data from the previous year (2015 to 2016) must only be amended in the current year (2016 to 2017) if it is incorrect due to an administrative error.

378. You **must not** amend the following fields (**see section 11.4 for further details**):

- Learning start date
- Learning planned end date.

Continuing learners who have an incorrect learning aim reference

379. On the incorrect learning aim, set the Completion status to code 3 'withdrawn' and the Withdrawal reason to code 40 'Learner has transferred to a new learning aim with the same provider'. Record the Learning actual end date with the same date as the Learning start date (this date will be in the previous ILR year).

380. Record a new learning aim with the correct Learning aim reference. The Learning start date and Learning planned end date must be the same as on the original (incorrect) aim. Do not amend the Learning start date or Learning planned end date. This should not be recorded as a restart.

Learners reported in 2016 to 2017 as continuing but who have now been identified as withdrawn

381. On the learning aim, set the Completion status to code 3 'withdrawn' and complete the Withdrawal reason with the relevant code. Record the Learning actual end date as the last day the learner was in learning (this date will be in the previous ILR year: do not use 1 August 2016).

382. You must add a Destination and Progression record for this learner.

Learners on a break in learning in 2015 to 2016 who have now been identified as withdrawn

383. On the learning aim, set the Completion status to code 3 'withdrawn' and complete the Withdrawal reason with the relevant code. Do not amend any of the dates or other aim data.

384. You must add a Destination and Progression record for this learner.

Continuing learners whose Learning planned end date has now been identified as significantly incorrect

385. On the learning aim, set the Completion status to code 3 'withdrawn' and complete the Withdrawal reason using code 40 'Learner has transferred to a new learning aim with the same provider'. Record a Learning actual end date of 1 August 2016.

386. Record a new learning aim with the same Learning aim reference and a Learning start date of 1 August 2016 and the correct Learning planned end date. Record this aim as a restart (Learning Delivery Funding and Monitoring Type = RES), and complete the Funding adjustment for prior learning field with the percentage of learning that is still to be delivered.

387. This data should only be changed when it is identified as incorrect due to administrative errors. The Learning planned end date must not be changed to take into account a revised planned end date due to a change in circumstances such as illness, slow progress or unemployment.

11.3 Changes to Learner details

388. Where there is a change in the learner's circumstances which does not lead to a change in their learning programme, for example a new address or a change in contact details, then the learner's data can be updated.

11.4 Changes to the Start and Planned End Dates

389. These fields inform the funding received. There **must not** be any changes made to the start or planned end information after the funding qualifying period, except to correct errors.

390. If the learner is transferring to a new learning aim or programme then the existing programme aim or learning aim must be closed and a new programme and/or learning aim(s) created.

391. The Learning planned end date must be entered at the start of the learning aim. It is important that this date is set realistically based on a range of factors including the learner's initial assessment, delivery patterns and historic performance.

392. You **must not** update the Learning planned end date once it has been entered, even if the learner continues on the learning aim beyond that date. If a learner continues their study beyond the planned end date then this should be reflected in the Learning actual end date field; the Learning planned end date must remain unchanged.

393. The Learning start date and Learning planned end date must remain the same between teaching years as they are used in the calculation of success rates.

11.5 Changes to the learning aim

394. All changes to learning objectives and aims must be recorded on the learner's Learning Agreement.

11.6 Changes to learning aims within the funding qualifying period

395. For SFA funded learners the funding qualifying period is defined in the [SFA funding rates and formula 2016 to 2017](#) document and is based on the number of days in learning for each learning aim.
396. For EFA funded learners, the qualifying period to be eligible for funding each year is defined in the [EFA rates and formula guide for 2016 to 2017](#) document, and is based upon the number of weeks in learning at Learner level.
397. If the learner changes their learning aim during the funding qualifying period then the learning aim details can be amended on the original ILR record.
398. Any changes to learning aims after the funding qualifying period must be recorded as a withdrawal or transfer.

11.7A learner is absent or withdraws

399. Providers must determine the intent of learners who are absent from learning, whether the learner expects to return to learning, and the reason for the absence. Providers are expected to have robust absence monitoring and an absence and withdrawal policy, which they implement to ensure that the progress of all learners is monitored.
400. A learner must be considered to have withdrawn from a programme when they have:
- made known a decision to withdraw from the programme,
 - exceeded the provider's absence and withdrawal policy, or
 - been removed from learning by the provider
401. When a learner withdraws, the programme aim (where applicable) and any learning aims should be closed as in Table 1:

Table 1: A learner has withdrawn from learning with no intention to return

Field Name	Data returned
Employment outcome	Returned if applicable
Completion status	3
Learning actual end date	Date of last learning activity for the aim
Withdrawal reason	Relevant code
Outcome	3
Outcome grade	Data not returned

402. Providers must include learners in the ILR who have attended one episode of learning. If a learner withdraws within the funding qualifying period, they must still be included in the ILR.
403. If the learner withdraws **without** completing one episode of learning - for example, without attending the first class - then they **must not** be included in the ILR.

11.8 Recording breaks in learning, transfers, and restarts

404. There are various circumstances where a learner may restart their learning, these include:
- Restarts after an agreed break in learning: see section 11.8.1
 - Restarts after a learner has transferred: see section 11.8.2
 - Restarts after withdrawing from a learning aim or apprenticeship: see section 11.8.3

11.8.1 Recording agreed breaks in learning

For SFA funded learners

405. If the learner is taking an **agreed** break in learning **and intends to return**, for example for economic reasons, long term sickness, maternity leave or religious trips, this should be recorded by closing the aims in the ILR as in Table 2.
406. You must not record a break in learning unless you and the learner have agreed this, the learner intends to return to learning at a later point, and there is supporting evidence in the learner file.
407. You must continue to report a learner on a break in learning in your ILR until either the learner returns and restarts their learning, or you report the learner as having withdrawn.
408. If the learner does not return from an agreed break in learning then the learning aim record(s) must be updated to indicate that the learner has withdrawn (see Table 1).
409. If the learner began an agreed break in learning in 2015 to 2016, is still on this break in 2015 to 2016 and they still intend to return, then the learning aims should continue to be returned in the 2016 to 2017 ILR as described in [Appendix B](#).

Table 2: A learner is SFA funded and taking an agreed break in learning

Field Name	Data returned
Employment outcome	Data not returned
Completion status	6
Learning actual end date	Date of last learning activity for the aim
Withdrawal reason	Data not returned
Outcome	3
Outcome grade	Data not returned

410. If the learning aim that the learner was following is no longer valid when they return (in other words, the certification date has passed), you cannot class this as a break in learning. This limits the length of time that a learner can have as a break in learning.
411. When the learner returns to learning, a new programme aim (if required) and learning aim(s) should be created as in Table 3. **The original learning aims must not be reopened.**

Table 3: Recording new aims when a learner returns from an agreed break in learning

Field Name	Programme Aim	Other Aims
Learning start date	Date on which the learner restarts the programme after the break	Date on which the learner restarts the learning aim after the break
Original learning start date (from 1 August 2013)	Date on which the learner originally started the programme	Date on which the learner originally started the learning aim
Learning planned end date	New planned end date for the programme	New planned end date for the learning aim
Funding adjustment for prior learning	Not returned	Proportion of the learning aim still to be delivered
Restart indicator (Learning Delivery FAM)	Use code RES1	Use code RES1
Eligibility for enhanced apprenticeship funding (Learning Delivery FAM)	Code 2 or 3 should be used where applicable for apprenticeship programmes only	Code 2 or 3 should be used where applicable for apprenticeship programmes only

412. If the learner has already completed the competency and/or knowledge aims of an apprenticeship programme prior to a break in learning, then these should continue to be returned as part of the learner's ILR records to ensure that the achievement element of funding from these is calculated correctly when the framework is achieved.

413. Additional guidance about recording agreed breaks in learning for apprenticeship programmes can be found in Section 12.

For EFA funded learners

414. The ILR does not record breaks in learning for EFA funded learners.

415. If an EFA funded learner has agreed a leave of absence with the provider then the learning aim record(s) should be left open. When the student completes their learning aim(s), these are closed in the normal way.

416. If the learner withdraws from learning then the learning aims are closed (see Section 11.7 above). If this learner later returns to the same programme of study, these aims can be reopened at the discretion of the provider depending upon the timing. For example, a learner withdraws in May 2016 and does not return until November 2016, then the aim in the 2015 to 2016 ILR will be recorded as withdrawn and new aims must be recorded in the 2016 to 2017 ILR with a Learning start date in November.

417. If a learner is absent on an agreed leave of absence at the start of a new teaching year, then the provider must continue to submit an ILR record for the learner and should record the planned hours that the learner will undertake for that year when they return to learning.

Qualification Achievement Rates (QARs) and breaks in learning

418. Aims recorded as on a break in learning (Completion status = 6) will be excluded from QARs according to the hybrid end year. However, they will be included in the following hybrid end year as a withdrawal if:

- They do not have a corresponding restart record in the same academic year as the agreed break was recorded, or
- They do not have a corresponding restart record in the following academic year, or
- They do not have a corresponding restart record in the R04 ILR return of the year after that.

419. For example, if an aim with a Learning planned end date in July 2015 was recorded with an agreed break in learning in April 2015 but did not have a restart record in 2014 to 2015, or 2015 to 2016, or by the R04 ILR return of 2016 to 2017, then it will be treated as a withdrawn aim in the 2015 to 2016 academic year.

420. Where the completion status of an aim recorded as an agreed break has been updated, we will use that information when calculating QARs and have amended the definition of the hybrid end year to become the later of the planned or actual end date or reported year. See the [business rules for qualification achievement rates](#) for further details.

11.8.2 Learner transfers

A learner transfers to a different learning aim within the same provider

421. If a learner changes their learning aim during the funding qualifying period then the learning aim details (including the start and planned end date) can be amended on the ILR record.

422. If a learner transfers to another programme or learning aim after the funding qualifying period, then the original learning aim record(s) will need to be closed and new learning aim(s) added: see Table 4. Providers should not just amend the details on the original learning aim(s).

Table 4: Recording a learner transfer to a new learning aim within the same provider

Closing aims

Field Name	Data returned
Employment outcome	Data not returned
Completion status	3
Learning actual end date	Date of the last learning activity for the aim
Withdrawal reason	40
Outcome	3
Outcome grade	Data not returned

Recording new aims after a transfer within the same provider

Field Name	Data returned
Learning start date	Date on which the learner starts the new learning aim
Original learning start date (from 1 August 2013)	Data not returned
Learning planned end date	Planned end date for the new aim
Funding adjustment for prior learning	If applicable
Restart indicator (FAM)	Data not returned

423. The start date of the new learning aim cannot be earlier than the actual end date of the learning aim that the learner has transferred from or may be slightly later if there is a delay in the learner starting the new aim.

A learner transfers from Adult skills non-apprenticeship learning to an apprenticeship framework with the same provider

424. Any learning aims that the learner will continue to study as part of the apprenticeship programme are left open and will continue to be recorded as non-apprenticeship learning. The Programme type, Framework code and Apprenticeship pathway fields are not completed for these aims. The funding model and other details (including the planned end date) of the learning aim must not be changed.

425. Any learning aims that the learner is not continuing with must be closed as in Table 4.

426. Any new aims required for the apprenticeship framework, including a programme aim, should be added to the learner’s record. The Programme type, Framework code and Apprenticeship pathway fields must be completed for these new aims.

427. Start and planned end dates for the programme aim and component aims of the apprenticeship framework need to be agreed and recorded. The start dates for these aims will be after the start date of the non-apprenticeship aim.

428. This does not apply to 16-18 year old learners who transfer from a study programme to an apprenticeship or vice versa with the same provider. In this situation, all the aims should be closed as in Table 4 and new aims started using the Funding adjustment for prior learning where applicable.

A learner transfers to a different provider

429. This guidance applies where an individual learner transfers to a different provider. For transfers of cohorts of learners due to contracting changes and changes in a provider’s organisational structure such as mergers and take-overs, see the section [A cohort of learners transfers to a new provider \(due to a merger\)](#) below.

430. Learners who transfer to a new provider before completing their learning aim or programme are recorded as shown in Table 5 below.

Table 5: Closing aims when a learner transfers to a different provider

Field Name	Scenario 1: Learner transfers to different learning aims with a different provider	Scenario 2: Learner is continuing the same learning aims with a different provider
Employment outcome	Data not returned	Data not returned
Completion status	3	3
Learning actual end date	Date of the last learning activity for the aim	Date of the last learning activity for the aim
Withdrawal reason	2 or 41 (as applicable) See paragraph 432 below for details of when to use code 41	2 or 7 (as applicable)
Outcome	3	3
Outcome grade	Data not returned	Data not returned

431. The new provider will create new learning aims for the learner (with new start dates and new planned end dates where applicable); see Table 6.

432. Withdrawal reason code 41 should only be used to identify where a learner has transferred from an EFA funded study programme or Adult skills funded learning in order to take up an apprenticeship programme, traineeship, or Supported Internship.

433. For provider changes due to minimum contract levels, code NLM18 should be recorded in the Learner Funding and Monitoring fields. For a merger or take-over, code NLM17 should be recorded: see [A cohort of learners transfers to a new provider \(due to a merger\)](#) below.

Table 6: Recording new aims when a learner transfers to a different provider

Field Name	Scenario 1: Learner transfers to different learning aims with a different provider	Scenario 2: Learner is continuing the same learning aims with a different provider
Learning start date	Date on which the learner starts the new learning aim	Date on which the learner restarts the learning aim (or date of merger or take-over, if applicable)
Original learning start date (from August 2013)	Data not returned	Data returned if known for mergers or take-overs
Learning planned end date	Planned end date for the new learning aim	New planned end date for the learning aim
Funding adjustment for prior learning	If applicable	The proportion of the learning aim still to be delivered (non-programme aims only)
Restart indicator (Learning Delivery FAM)	Data not returned	Use code RES1
Eligibility for enhanced apprenticeship funding (Learning Delivery FAM)	Data not returned	2 or 3 (if applicable)
National Learner Monitoring (Learner FAM)	Use code NLM17 or NLM18 (if applicable)	Use code NLM17 or NLM18 (if applicable)

434. For OLASS learners, a change in unit of procurement that results in a change in provider is recorded in the same way as a learner transfer to a different provider (see above). The learning aims with the original unit of procurement must be closed and new learning aims recorded with the new unit of procurement. Where the learner is continuing the same learning aims with the new unit of procurement see Scenario 2 in Table 6.

A cohort of learners transfers to a new provider (due to a merger)

435. When providers merge, the approach required to record the learners on the ILR is dependent on the provider type.

436. For Training Organisations (contract funded providers)

Learners must be transferred individually following the guidance in the section above (A learner transfers to a different provider). On the new provider's ILR data, the Learner FAM code NLM17 must be recorded for all learners who transferred due to the merger.

437. For Colleges (grant funded providers)

Colleges merging must continue to return all learners for the rest of the ILR reporting year (up to and including R14). From 1 August of the following academic year, you should amend the UKPRN on the ILR records and complete the UKPRN in previous year field with the previous UKPRN. The field Learner reference number in previous year should also be completed, where applicable.

11.8.3 Recording restarts (without an agreed break in learning)

438. The following guidance applies in scenarios such as where a learner has withdrawn from their learning for a reason other than an agreed break in learning or transfer, and subsequently returns to learning on the same aim(s). See sections 11.8.1 and 11.8.2 above for details about how to record agreed breaks in learning and transfers.

439. When the learner withdraws, their learning aims must be closed as in Table 1, with an appropriate Withdrawal reason.

440. If the learner later returns to learning, then new aims must be created as in Table 7. The original learning aims must not be reopened.

Table 7: Recording new aims when a learner restarts learning without an agreed break

Field Name	Programme Aim	Other Aims
Learning start date	Date on which the learner restarts the programme	Date on which the learner restarts the learning aim
Original learning start date (from 1 August 2013)	Not returned	Not returned
Learning planned end date	New planned end date for the programme	New planned end date for the learning aim
Funding adjustment for prior learning	Not returned	Proportion of the learning aim still to be delivered (if applicable)
Restart indicator (Learning Delivery FAM)	Use code RES1	Use code RES1
Eligibility for enhanced apprenticeship funding (Learning Delivery FAM)	Not returned	Not returned

11.9 Recording learning outcomes

441. The ILR must be completed and updated regularly to reflect progress in the learner's Learning Agreement. Information should be updated when the outcome of the learning is known.

442. The Employment outcome field is only completed for learning aims which are either part of a programme that is funded to deliver employment outcomes or a programme where separate employment outcome payments are made.

443. Table 8 below illustrates how to record:

- Continuing aims, and
- Achieved aims

Table 8: Recording continuing and achieved aims

Field Name	Continuing aims	Achieved aims
Employment outcome	Data not returned	Return if applicable
Completion status	1	2
Learning actual end date	Data not returned	Date of the last learning activity for the aim
Withdrawal reason	Data not returned	Data not returned
Outcome	Data not returned	1 – non AS levels 6 or 7 – AS levels
Outcome grade	Data not returned	Relevant grade, see <i>Appendix Q</i>

444. In the scenario where a learner undertakes an aim, finishes learning, takes the final assessment and fails, then this aim should be closed and recorded as not achieved. Where this learner is then identified as needing further support or additional learning in order to pass the assessment, then a new learning aim should be recorded as a restart with the Funding adjustment for prior learning completed to account for the new learning required to pass the resit. However, if no further learning is required and the learner is only resitting the exam, then this is not funded by the SFA and a new aim must not be recorded.

11.10 How to delete records

445. Erroneous learner records can be deleted from data held by the SFA by sending a file with the erroneous learner and associated learning aims and/or learner destination and progressions records removed from the file.

446. Learner records should not be deleted unless the learner withdraws without completing one episode of learning, for example the learner withdraws without attending the first class.

447. Where files have been merged using the amalgamation functionality of FIS, care should be taken to ensure that the learner is deleted correctly.

448. Providers should keep a record of learner deletions.

Section 12 : Recording apprenticeship programmes

449. This section is a guide to recording apprenticeship programmes in the ILR, which include Intermediate-level Apprenticeships, Advanced-level Apprenticeships, and Higher and Degree Apprenticeships. This section only applies to apprenticeships started, or originally started, prior to 1 May 2017. For guidance about recording apprenticeships that start on or after 1 May 2017, refer to the [Guidance for returning apprenticeships on the ILR from 1 May 2017](#).

450. This guidance is split into the following sections:

- Guidance that applies for all apprenticeship programmes
- Additional guidance for apprenticeship frameworks
- Additional guidance for apprenticeship standards
- Additional guidance for recording Higher and Degree apprenticeships
- Requirements for Higher Education Institutions (HEIs)

451. For 2016 to 2017, guidance for apprenticeship standards has been incorporated into this support manual, this was previously published as a separate document. For guidance that applies only to apprenticeship standards (for example, how to record financial details for the apprenticeship programme), see section 12.3 below.

12.1 Guidance for all apprenticeship programmes

452. Apprenticeship programmes are composed of one programme aim, and a number of component learning aims (competency, knowledge and functional skills).

453. The Aim type field is used to identify whether a learning aim is a programme aim, or component aim in the ILR;

- A programme aim is recorded using code 1 in the Aim type field
- A component aim is recorded using code 3 in the Aim type field.

454. All apprentices must have a National Insurance (NI) number. The NI number does not need to be returned until the apprentice starts on their programme or shortly after: you should make this clear on any enrolment system or data collection form.

NI numbers **cannot** be issued on request to young people below the age of 15 years 9 months. HMRC issues NI numbers to all young people between the ages of 15 years 9 months and 15 years 11 months so that they have a number when they reach the age of 16 and can start an apprenticeship.

12.1.1 Recording employment status for apprenticeships

455. For all apprentices, you must return an employment status record of the apprentice's employment status prior to the start of the programme.

456. A new employment status record with a Date employment status applies of the first day of the apprenticeship programme must be added under the following circumstances:

- The apprentice was unemployed prior to starting the programme, or
- The apprentice was employed with a different employer prior to starting their programme.

457. All apprentices must have an employment status record that applies on the first day of their programme with an employment status of 'In paid employment' (Employment status code 10) and Employment intensity of 16 hours or more (ESMType = EII and ESMCode <> 2), except where the alternative completion conditions apply for an apprenticeship framework. Refer to the [Apprenticeships: common funding rules](#) for full details.

458. Employment status data is used to monitor and ensure apprentice eligibility for funding; care must be taken to complete employment status records accurately.

Examples

1. Apprentice who is unemployed prior to starting the programme

A learner starts an apprenticeship programme on 15 September 2016 with ABC engineering. The learner was unemployed and looking for work prior to starting the apprenticeship.

- An Employment status record with a date prior to 15 September 2016 is recorded with a status of “Not in paid employment and looking for work and available to start work” (code 11).
- A second Employment status record with a date of 15 September 2016 is recorded with a status of “in paid employment” (code 10). The Employer identifier for ABC engineering is recorded.

2. Apprentice who is employed with a different employer prior to starting the programme

A learner starts an apprenticeship programme on 28 September 2016 with ABC engineering. The learner was employed in the week prior to starting the apprenticeship with a different employer.

- An Employment status record with a date prior to 28 September 2016 is recorded with a status of “in paid employment” (code 10). No Employer identifier needs to be recorded.
- A second Employment status record with a date of 28 September 2016 is recorded with a status of “in paid employment” (code 10). The Employer identifier for ABC engineering is recorded.

3. Apprentice who changes employer and progresses to a second apprenticeship programme

- The learner progresses from an Intermediate-level Apprenticeship framework to an Advanced-level Apprenticeship framework on 4 June 2017 with a new employer (DEF engineering).
- A new Employment status record with a date of 4 June 2017 is recorded with a status of “in paid employment” (code 10). The Employer identifier for DEF engineering is recorded.

459. A new employment status record must be added to accurately record any change in the apprentice’s employment status or employment status monitoring (for example, a change in the apprentice’s employer or hours of work) during their programme.

460. If the employment status of the apprentice changes, there are circumstances that would make the apprentice ineligible for funding; refer to the [Apprenticeships: common funding rules](#) for details.

12.1.2 Creating programme aims and component aims

461. The programme aim relates to the overall apprenticeship framework **or standard** and so it may have a start date, end date and completion status that differs from the component aims. There **must** always be a programme aim recorded in order to capture the overall programme details.

462. Providers should take care to complete the following fields accurately:

- Learning aim reference number (make sure this number is a valid code in the LARS database)
- Aim type
- Funding model
- Programme type – this should be the same for all learning aims that comprise the programme
- Framework code – this should be the same for all learning aims that comprise the programme **(apprenticeship frameworks only)**
- Apprenticeship Pathway – this field must match the data held in the LARS database at the start of the programme and should be the same for all learning aims that comprise the programme **(apprenticeship frameworks only)**
- Apprenticeship standard code – this should be the same for all learning aims that comprise the programme **(apprenticeship standards only)**
- Learning start date (this should reflect reality. For example, record when a specific English/maths functional skills aim or framework knowledge element is due to start.)
- Learning planned end date (this should reflect how long the learner is expected to be following the aim. This field will affect how funding is distributed **for framework programmes**)
- Source of funding – this is recorded as a Learning Delivery Funding and Monitoring (FAM) record using FAM type SOF

12.1.3 Eligibility for enhanced apprenticeship funding

463. Eligibility for enhanced apprenticeship funding is recorded as a Learning Delivery FAM record in the ILR.

464. The table below shows the FAM Types and Codes to be used to indicate eligibility for enhanced apprenticeship funding:

FAM Type	FAM Code	Description	To be used where
EEF	2	Entitlement to 16-18 apprenticeship funding where the learner is 19 or over	The learner is restarting a programme on or after their 19 th birthday but is entitled to 16-18 funding. The learner is aged 19-24 and has an EHC plan or LDA.
EEF	3	Entitlement to 19-23 apprenticeship funding where the learner is 24 or over	The learner is restarting a programme on or after their 24 th birthday but is entitled to 19-23 funding.
EEF	4	Entitlement to extended funding for apprentices aged 19 to 24	The learner was aged 19-24 at the start of the apprenticeship and is eligible for extended funding (frameworks only) or the additional 16-18 employer incentive (standards only). See the Funding Rules for details about extended funding and the additional 16-18 employer incentive for apprentices aged 19 to 24.

465. Where the apprentice is recorded with the FAM type EEF due to restarting their programme, the Restart indicator (RES) must also be recorded in the Learning Delivery FAM fields.

12.1.4 Apprenticeship training agencies (ATAs)

466. Organisations that operate as ATAs employ apprentices who are then made available to employers for a fee. The reporting of apprentices employed with an ATA is subject to monitoring and ministerial reporting. You must ensure that this data is accurately completed on your ILR return.

467. Apprentices who are employed with an ATA should be recorded in the ILR in the same way as other apprentices, paying particular attention to the following:

- Record code LDM130 in the Learning Delivery Funding and Monitoring fields against **all** aims delivered as part of the apprenticeship where the apprentice is directly employed by an ATA who then hires them out to a host employer. This applies to the programme aim and all component aims.
- The employer number of the ATA **must** be recorded in the Employer identifier field. This field should not contain the employer number of the host employer.
- The delivery location postcode for each learning aim should record where the delivery took place. For example, if the competency aim for an apprenticeship framework is delivered at the host employer's workplace, then the postcode of the host employer should be recorded for this aim. If the **knowledge learning aim for the apprenticeship framework** is delivered by the training provider then the postcode of the provider should be recorded for this aim.

Examples

1. An apprentice is employed with an ATA that is working with a range of training providers

- The Employer identifier in the Employment status record applicable on the first day of learning is the employer number for the ATA.
- The Delivery location postcode for the learning delivered within the workplace, such as a framework competency aim, is the host employer's postcode.
- The Delivery location for learning aims delivered at a training provider is the postcode of the relevant training provider.
- The code LDM130 is recorded against all aims delivered as part of the programme, including the programme aim and all component aims.

2. An apprentice is employed with an ATA that is also a training provider

- The Employer identifier in the Employment status record applicable on the first day of learning is the employer number for the ATA. This must be a different number to the employer number of the training provider; see the [Apprenticeships: common funding rules](#).
- The Delivery location postcode must be recorded as in example 1 above.
- Code LDM130 must be recorded against all aims delivered as part of this apprenticeship programme, including the programme aim and all component aims.

468. Group training associations (GTAs) that offer an ATA service to employers must follow ATA-specific rules, but must record code LDM129 in the Learning Delivery Funding and Monitoring fields.

12.2 Additional guidance for apprenticeship frameworks

469. The Apprenticeships, Skills, Children and Learning (ASCL) Act introduced the Specification of Apprenticeship Standards for England (SASE). The SASE sets out the minimum requirements to be included in an apprenticeship framework.
470. All apprenticeship starts in 2016 to 2017 must comply with the latest framework specification.
471. Further information on the SASE is available on the apprenticeships website at <https://www.gov.uk/government/publications/specification-of-apprenticeship-standards-for-england>.
472. The tables on pages 117 to 119 provide additional guidance about completing ILR data for apprenticeship frameworks, including how to complete programme and component learning aim Learning Delivery fields.

12.2.1 Apprenticeship framework eligibility for enhanced apprenticeship funding

473. In addition to the scenarios in section 12.1.3, Eligibility for enhanced apprenticeship funding may also be applicable for apprenticeship frameworks when a learner changes pathway within the same framework. See section 12.2.3 for details of recording a pathway transfer.
474. For framework apprenticeships, where EEF code 2 is recorded then FFI code 1 (fully funded) must also be recorded. Where EEF code 3 is recorded then FFI code 2 (co-funded) must be recorded.

12.2.2 Recording framework achievements

475. When all the elements of the apprenticeship have been completed and the Apprenticeship Declaration and Authorisation Form has been signed, the following should be recorded:
- All the learning aims within the programme must be closed with Learning actual end date set to the date of the last learning activity for the aim(s).
 - The programme aim should be closed with the Learning actual end date recorded as the last learning activity for the entire programme.
 - The Outcome on the programme aim should be recorded as code 1 'Achieved'.
476. All open and closed learning aims that are part of the framework should be returned on the ILR for an apprenticeship programme until the framework is completed. To calculate the framework achievement funding for an apprenticeship, both the competency and knowledge aims must be recorded when the framework is achieved.
477. Where a learner achieves an apprenticeship programme but is continuing with level 2 functional skills (having progressed from level 1 during the apprenticeship), the programme aim should be closed with an Outcome of 'Achieved' along with the competency and knowledge aims as detailed above. The level 2 functional skills aims can remain open and should continue to be recorded until they are completed.
478. If a learner starts an Advanced-level Apprenticeship and is continuing with level 2 functional skills that they started during an Intermediate-level Apprenticeship, then the learning aim records for the functional skills do not need to be closed or amended. The Programme type, Framework code and Apprenticeship pathway fields will remain the same.
479. The SFA will pay apprenticeship framework achievements in the year in which the learner completes the framework (based on the Learning actual end date of the programme aim). The funding calculation will look at the Outcome field to determine if the framework is achieved.

480. Where the framework is completed and achieved before 31 July 2017, this should be recorded in the 2016 to 2017 data returns.

12.2.3 Recording transfers for apprenticeship frameworks

Transfers to a different apprenticeship framework or pathway

481. If a learner who is undertaking an apprenticeship framework programme changes to a new framework or new pathway:

- Close the programme aim and any learning aims that the learner is no longer continuing with (see the 'Closing aims' column in Table 4).
- Create a new programme aim and new learning aims if required, for example where the learner is doing a different competency aim. Record the new framework/pathway being undertaken in the Framework code and Apprenticeship pathway fields (see Table 9).

Table 9: Recording new aims when a learner transfers to a different apprenticeship framework or pathway

Field Name	Programme Aim	Other Aims
Learning start date	Date on which the learner starts the new programme	Date on which the learner starts the new learning aim
Original learning start date (from 1 August 2013)	Data not returned	Data not returned
Learning planned end date	Planned end date for the new programme	Planned end date for the new aim
Framework code	New framework code	New framework code (as applicable)
Apprenticeship pathway	New apprenticeship pathway code	New apprenticeship pathway code (as applicable)

- If the learner is continuing with any of their existing learning aims as part of the new framework or pathway then these learning aims do not need to be closed. The Framework code and Apprenticeship pathway fields should be amended to the new framework/pathway. The Learning start and planned end dates for these aims should not be amended.
- If the learner has already completed the competency and/or knowledge aims of the programme prior to transferring to a new framework/pathway, then the Framework code and Pathway code on those aims should also be amended to reflect the new framework/pathway. This will ensure that the achievement element of funding from these is calculated correctly when the framework is achieved.
- The framework and pathway codes do not need to be amended for functional skills that have already been completed and will continue to record the previous framework/pathway codes.
- If the learner is continuing on the same framework but has changed pathway, the Funding and Monitoring type EEF (Eligibility for enhanced apprenticeship funding) should be recorded in the following circumstances:
 1. Record EEF code 2 if the learner was aged 16-18 when they started their apprenticeship programme but is aged 19 or over when they transfer to the new pathway.
 2. Record EEF code 3 if the learner was aged 19-23 when they started their apprenticeship programme but is aged 24 or over when they transfer to the new pathway.

482. In all cases, the ILR should be completed to reflect the reality of the learner's situation.

Progressing from one apprenticeship framework level to another

483. If a learner progresses from an Intermediate-level Apprenticeship to an Advanced-level Apprenticeship, two programme aims would be recorded:

- One closed and completed programme aim for the Intermediate-level Apprenticeship, and
- One open and current programme aim for the Advanced-level Apprenticeship

484. The Learning start date for the new apprenticeship programme aim should not overlap with the Learning actual end date for the closed apprenticeship programme aim.

485. The Learning Delivery Funding and Monitoring entry for Full or co-funding indicator (FFI) should be set based on the date the learner started the new framework.

Example

A learner starts an Intermediate-level Apprenticeship aged 18. They complete the Intermediate-level and move on to an Advanced-level Apprenticeship, starting the Advanced-level when they are over 19.

- The FFI indicator would be recorded as 1 'Fully funded learning aim' on the Intermediate-level Apprenticeship.
- The FFI indicator would be recorded as 2 'Co-funded learning aim' on the Advanced-level Apprenticeship as the learner is now over 19.

486. You should also refer to section 12.2.2 for details of how to record framework achievements and progressions for learners who are continuing with level 2 functional skills (having progressed from level 1 during the apprenticeship).

12.3 Additional guidance for apprenticeship standards

487. Data about each apprenticeship standard learner must be reported in the ILR by a single lead provider as set out in the [apprenticeship standard funding rules](#).

488. The tables on pages 120 to 122 provide additional guidance about completing ILR data for apprenticeship standards, including how to complete programme and component learning aim Learning Delivery fields.

12.3.1 Recording employment status and identifying small employers

489. You must record employment status for all apprentices as in section 12.1.1 above.

490. Small employers (as defined in the apprenticeship standard funding rules) should be identified on the ILR by returning code SEM1 in the Employment Status Monitoring fields. This data is used to indicate if the employer recorded in the Employer identifier field is eligible to earn the small employer incentive payment.

12.3.2 Recording apprenticeship standard learning aims

491. Every apprenticeship standard programme must have a programme aim and at least one component aim recorded.

492. All learning undertaken as part of the programme, including regulated and non-regulated qualifications, must be recorded on the ILR.

- 493. If no regulated qualifications are undertaken as part of the programme, you should record one of the non-regulated learning aims held in the LARS database as the component aim. These non-regulated codes should be taken from Category E of Appendix H. See section 9.8.2 for more details about recording non-regulated aims.
- 494. If there has been a delay with the publication of the accredited qualification specified in the apprenticeship standard document then you can temporarily record a proxy aim by following the guidance in section 9.8.4.
- 495. All apprenticeship standard aims must be recorded using Funding model code 81 (Other SFA funding) and Programme type code 25 (apprenticeship standard).
- 496. You must complete the Apprenticeship standard code field with the code for the standard from the LARS database.

Example

- A learner is undertaking an apprenticeship programme in the Software Development standard. As part of this, the learner is completing some IT learning that is not a regulated qualification. This non-regulated learning is recorded as a component learning aim with the appropriate learning aim reference from Appendix H: Z0001946 - 'Non regulated provision, Level 4, ICT Practitioners'.

This apprenticeship is recorded on the ILR with the following two aims:

1. Programme aim: LearnAimRef = ZPROG001, AimType = 1
2. Component learning aim: LearnAimRef = Z0001946, AimType = 3

The standard is recorded in the Apprenticeship standard code field using code 2.

497. The tables on pages 120 to 122 contain details of which ILR fields should be completed for apprenticeship standards.

498. The Learning planned end date for the apprenticeship programme aim must include both the training and end point assessment period. This date is used in validation to enforce the minimum duration requirements for an apprenticeship standard programme as specified in the [funding rules](#).

499. You must record the Source of funding in the Learning Delivery Funding and Monitoring fields using code SOF105 (SFA). Other Learning Delivery Funding and Monitoring (FAM) fields should be completed as applicable using the relevant FAM types and codes.

12.3.3 Recording financial data for apprenticeship standards

500. Each apprenticeship standard programme will have a number of separate financial records associated with the programme aim. You must record the financial information about the apprenticeship standard programme in the Trailblazer Apprenticeship Financial Records. This information is used to calculate the government funding for the apprentice.

501. The figure below illustrates the structure of these records:

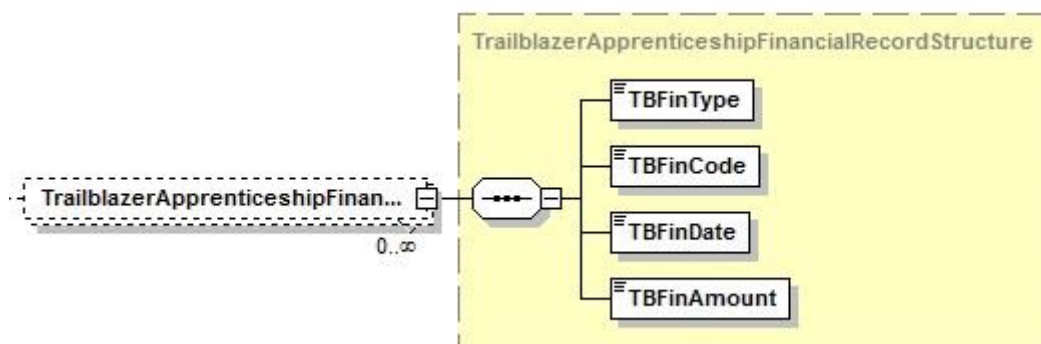

502. The Trailblazer Apprenticeship Financial Record dataset contains the following fields:

Field Name	Definition
Trailblazer financial type	Indicates the type of financial information being recorded: <ul style="list-style-type: none"> • TNP identifies total negotiated price details • PMR identifies payment records
Trailblazer financial code	Identifies different types of TNP or PMR records
Trailblazer financial record date	The date associated with the financial record
Trailblazer financial amount	The amount of money recorded on the financial record. This is the actual amount in pounds (to the nearest whole pound) and is the amount excluding VAT.

503. There are two Trailblazer financial types that can be recorded:

- **Total negotiated price (TNP)**: this is the total price agreed for delivery of all the training and assessment for the apprenticeship programme. This value is the cost to the provider for the delivery of the apprenticeship programme and must include both the employer co-payment contribution and the government co-payment funding.
- **Payment record (PMR)**: the individual payment records of the cash contributions from the employer to the training provider or assessment provider.

504. The table below lists the different codes available for each financial type:

Trailblazer financial type	Trailblazer financial code	Description and use
TNP	1	Total negotiated training cost
TNP	2	Total negotiated assessment cost
PMR	1	Payment record of cash contribution made by employer to provider for training costs
PMR	2	Payment record of cash contribution made by employer to provider for assessment costs
PMR	3	Employer payment for training or assessment reimbursed by provider. This must not be used to record transfer of incentive payments to the employer.

505. At the start of the apprenticeship, you should record two TNP records: one for the total negotiated price for the training (TNP1) and one for the total negotiated price of the assessment (TNP2) as agreed between the employer and provider. **You must record an agreed training price (TNP1) at the start of the programme.** Set the Trailblazer financial record date on these records to the start date of the apprenticeship programme.

506. If the assessment price (TNP2) has not been agreed at the start of the programme, then this can be recorded at a later point. This price must be agreed and recorded on the ILR before any assessment payments (PMR2) are recorded.

507. The Trailblazer financial amount recorded against TNP1 and TNP2 must equal the total cost to the provider for delivery of the entire apprenticeship programme, this includes:

- the employer co-payment contribution, and
- the government co-payment funding.

508. The values recorded in the TNP records must be the total cost for the delivery of the whole apprenticeship programme and not just the value for the current year.

509. If a new price for training, assessment, or both is negotiated then new TNP records must be added. The financial record date must be set to the date the new price was agreed.

510. You must agree a payment schedule with the employer for the required cash contributions.
511. When you have received a cash payment, you must record this on the ILR using a separate payment (PMR) record for each payment that the employer makes to you. This must include the date you received payment from the employer and the amount of the payment (in pounds, to the nearest whole pound).
512. The payment records are used to calculate and trigger government funding. When government funding is triggered, for grant funded providers this amount is earned against your allocation. For contract funded providers, this amount is released in the next payment run.
513. The amount entered on the payment records must not include the VAT element where this exists.
514. The payment records must only be used to record payments actually received from the employer. They should not be used to record what the employer is expected to pay, nor should it record the Skills Funding Agency's contribution.
515. You must ensure that the Trailblazer Apprenticeship Financial Record dataset is accurate because this is used in the calculation and payment of government co-payment funding. In particular, please ensure that the financial amounts and dates recorded are correct as these will impact funding.
516. The Trailblazer Apprenticeship Financial Record dataset must contain all payment records for the full duration of the programme. Where a programme is continuing across academic years, all Financial Record data from the previous year must be migrated into the current ILR and continue to be returned until the programme ends.

Example

- A learner began an apprenticeship standard on 1 October 2015 with a negotiated price for training of £12,000. The provider receives a payment from the employer of £1,000 for this programme on 1 November 2014. The following Financial details are returned in 2015 to 2016:

TBFinType	TBFinCode	TBFinDate	TBFinAmount
TNP	1	01/10/2015	£12,000
PMR	1	01/11/2015	£1,000

- The learner is continuing their programme in the 2016 to 2017 academic year. The provider receives another payment of £1,000 for this programme on 1 October 2016. The following Financial details are returned in 2016 to 2017:

TBFinType	TBFinCode	TBFinDate	TBFinAmount
TNP	1	01/10/2015	£12,000
PMR	1	01/11/2015	£1,000
PMR	1	01/10/2016	£1,000

517. For more information about apprenticeship standards payments and funding, refer to the [apprenticeship standards funding rules](#).

Example of a Financial Details Record:

- A learner starts on a Software developer apprenticeship on 1 September 2016 with a planned end date of 30 September 2018. This apprenticeship standard has a funding cap of band 5.
- A price for training of £12,000 is agreed prior to the start of the programme, this value is the total cost to the provider and indicates an employer co-payment contribution of £4,000 and government co-payment funding of £8,000.
- A price for assessment of £6,000 is also agreed prior to the start of the programme, this indicates an employer co-payment contribution of £2,000 and government co-payment funding of £4,000.
- The lead provider records two financial records in the ILR; one with Financial type TNP code 1 and one with Financial type TNP code 2. Both of these records have a Financial record date of the start date of the apprenticeship programme (1st September 2016). See rows 1 & 2 in the table below.
- The employer makes cash contribution payments to the lead provider according to an agreed payment schedule. The lead provider receives a payment of £2,000 from the employer on 2 September 2016, as agreed. The provider records this payment in the Trailblazer Apprenticeship Financial Record entity using Financial type PMR code 1 (see row 3 in the table below).
- A core government contribution (CGC) of £4,000 is triggered for the lead provider.
- On 2 February 2017, the lead provider receives a payment of £2,000 from the employer as per the payment schedule and records this in the ILR (see row 4 in the table below).
- A second CGC of £4,000 is triggered for the lead provider.
- On 2 July 2017, the lead provider receives a payment towards the end point assessment of £2,000 from the employer as per the payment schedule and records this in the ILR (see row 5 in the table below)
- Cash contribution payments made by the employer continue to be recorded for the duration of the apprenticeship. Each time a payment is recorded on the ILR, a CGC payment is triggered until either 2/3 of the agreed total price has been paid or the core government contribution cap has been reached.
- The table below illustrates the Financial records for this example and the SFA funding (CGC) associated with it:

TBFinType	TBFinCode	TBFinDate	TBFinAmount	SFA funding triggered	SFA funding to date
TNP	1	01/09/2016	12,000		
TNP	2	01/09/2016	6,000		
PMR	1	02/09/2016	2,000	£4,000	£4,000
PMR	1	02/02/2017	2,000	£4,000	£8,000
PMR	2	02/07/2017	2,000	£4,000	£12,000

12.3.4 Recording eligibility for employer incentives

518. For 2016 to 2017, there are three employer incentives available for apprenticeship standard programmes. The following guidance describes what you need to record on the ILR in order to trigger these incentive payments. Further details about these incentives can be found in the [apprenticeship standards funding rules](#).

519. **The 16-18 apprentice incentive**, which is earned for 16 to 18 year old apprentices, is triggered based on the apprentice's age at the start of their apprenticeship standard programme. You do not need to record additional data on the ILR to trigger this incentive, the apprentice's age at the start of the programme is automatically calculated. This incentive is paid in two parts: 50% after 90 days on the programme and 50% after 12 months on the programme.

520. **The small employer incentive**, which is earned for employers with fewer than 50 employees, is triggered based on the apprentice's employment status data. See section 12.3.1 for details about how to identify an employer as a small employer. This incentive is paid in full after 90 days on the programme.

521. **The completion incentive**, which is earned when an apprentice successfully completes their end point assessment and achieves the apprenticeship standard, is triggered based on data in the following Learning Delivery fields: Completion status, Outcome and Achievement date. This incentive is paid in full once the programme has been recorded on the ILR as completed (Completion status code 2) and achieved (Outcome code 1), the Achievement date is used as the trigger date for the incentive.

12.3.5 Recording learner changes for apprenticeship standards

522. Refer to the [apprenticeship standard funding rules 2016 to 2017](#) for the rules regarding changes in learner circumstances, such as agreed breaks in learning, withdrawals, transfers from one provider to another, or changes in employment.

523. Following a change in circumstances, you may need to reimburse the employer for learning that has already been paid for but that has not yet been delivered. If this is the case then you should record a payment record using code PMR3, the amount of this record should reflect the payment returned to the employer. This will enable to SFA to recover any overpayment of the core government contribution (CGC) that has been made.

Apprentice is absent or withdraws from the apprenticeship standard

524. The programme aim and learning aims should be closed, see section 11.7.

525. Any payment adjustments needed should be recorded using PMR records.

Example

- *An apprentice starts on an apprenticeship standard on 15 September 2016 then withdraws on 20 May 2017:*

	Learning start date	Learning planned end date	Learning actual end date	Completion status	Outcome	Withdrawal reason
Programme aim	15 Sep 2016	30 Nov 2018	20 May 2017	3	3	Relevant code

- *The Financial records for this apprentice are below.
When the apprentice withdraws, the employer has already paid all of their employer contributions for the training (£5,000) and the provider has received the full government contribution of £10,000 for the training.*

However, only £12,000 of the total training has been delivered when the apprentice withdraws. The provider needs to reimburse the employer for an overpayment of £1,000 (recorded here as a PMR3 record), this will then enable the government contribution to be reclaimed.

TBFinType	TBFinCode	TBFinDate	TBFinAmount	SFA funding triggered	SFA funding to date
TNP	1	15/09/2016	15,000		
TNP	2	15/09/2016	3,000		
PMR	1	01/12/2016	3,000	£6,000	£6,000
PMR	1	01/04/2017	2,000	£4,000	£10,000
PMR	3	01/06/2017	1,000	-£2,000	£8,000

Apprentice takes an agreed break in learning

526. The programme aim and component learning aims should be closed when an apprentice takes an agreed break in learning.

527. When the apprentice returns, a new programme aim and new component aims are recorded. The total negotiated price (TNP) records must be recorded on the new programme aim, even if they are unchanged from those recorded on the first programme aim.

528. Any new employer payments that are received following the break in learning must be recorded against the new programme aim.

529. The previous programme aim, financial records, and component learning aims must continue to be recorded on the ILR until the apprenticeship standard is completed. The sum of all PMR records across both programme aims are used to calculate CGC payments.

Example

- An apprentice starts on an apprenticeship standard on 15 September 2016 then takes an agreed break in learning from 20 May 2017. On 8 August 2017 they return to their programme:

	Learning start date	Learning planned end date	Learning actual end date	Completion status	Outcome	Withdrawal reason
Programme aim 1	15 Sep 2016	30 Nov 2018	20 May 2017	6	3	Data not returned

	TBFinType	TBFinCode	Amount	Date	SFA funding triggered	SFA funding to date
Financial records	TNP	1	15,000	15 Sep 2016		
	TNP	2	3,000	15 Sep 2016		
	PMR	1	3,000	1 Dec 2016	£6,000	£6,000

	Learning start date	Learning planned end date	Learning actual end date	Completion status	Restart indicator	Original learning start date
Programme aim 2	8 Aug 2017	15 Feb 2019		1	RES1	15 Sep 2016

	TBFinType	TBFinCode	Amount	Date	SFA funding triggered	SFA funding to date
Financial records	TNP	1	15,000	8 Aug 2017		£6,000
	TNP	2	3,000	8 Aug 2017		£6,000
	PMR	1	2,000	1 Dec 2017	£4,000	£10,000
	PMR	2	1,000	1 Dec 2018	£2,000	£12,000

Apprentice transfers to a different apprenticeship standard (with the same provider)

530. The programme aim and any component learning aims that the apprentice is not continuing with should be closed.
531. Any payment adjustments needed (e.g. reimbursements) should be recorded using PMR records.
532. A new programme aim is recorded with the new apprenticeship standard code (StdCode) in the Learning delivery fields. The StdCode is amended on any continuing aims.
533. The new price agreed for the training and assessment is recorded against the new programme aim with new TNP1 and TNP2 records.

Example

- An apprentice starts an apprenticeship standard (StdCode 11) on 15 September 2016. The apprentice changes to a different standard (StdCode 5) on 20 May 2017.
- Programme aim 1 is closed as a transfer and a new record is added for Programme aim 2. Component aim 2 is closed as a transfer and a new record is added for component aim 3. The apprentice continues with the Maths aim (component aim 1) and so this record is left open and the StdCode is changed on this aim from 11 to 5.
- The provider has only delivered £6,000 worth of training at the point at which the apprentice transfers so the employer is repaid £1,000 and £2,000 of government funding is reclaimed. This is recorded using a PMR3 record on programme aim 1.
- A new total price is agreed for the new standard, taking into account any relevant learning from the first standard. The new total price is recorded on the new programme aim (programme aim 2) together with the employer contributions towards the new standard.

	Learning start date	Learning planned end date	Learning actual end date	Completion status	Outcome	Withdrawal reason	StdCode
Programme aim 1	15 Sep 2016	30 Nov 2018	20 May 2017	3	3	40	11
Component aim 1 (maths)	15 Sep 2016	30 Sep 2017		1			44 5
Component aim 2	15 Sep 2015	30 Sep 2018	20 May 2017	3	3	40	11

Financial records	TBFinType	TBFinCode	Amount	Date	SFA funding triggered	SFA funding to date
	TNP	1	16,000	15 Sep 2016		
	TNP	2	3,000	15 Sep 2016		
	PMR	1	3,000	1 Dec 2016	£6,000	£6,000
	PMR	3	1,000	20 May 2017	-£2,000	£4,000

	Learning start date	Learning planned end date	Learning actual end date	Completion status	Outcome	Withdrawal reason	StdCode
Programme aim 2	21 May 2017	15 Feb 2019		1			5
Component aim 3	21 May 2017	15 Feb 2019		1			5

Financial records	TBFinType	TBFinCode	Amount	Date	SFA funding triggered	SFA funding to date
	TNP	1	11,000	21 May 2017		
	TNP	2	1,000	21 May 2017		
	PMR	1	3,000	1 Sep 2017	£6,000	£6,000
	PMR	2	1,000	1 Dec 2018	£2,000	£8,000

Apprentice changes employer but continues with the same apprenticeship standard (with the same provider)

534. A new employment status record is added for the apprentice with the Employer identifier of the new employer.
535. No changes are made to the programme aim and component learning aim records for the apprentice.
536. New TNP records should only be recorded when the total training and/or assessment price for delivery of the whole apprenticeship programme have changed following re-negotiation with the new employer. The TNP records must continue to record the total training and assessment costs for the entire standard and must not be changed to reflect the proportion of the cost that remains to be paid by the new employer.

Apprentice transfers to a different provider (on a new or the existing standard)

537. The original provider closes the ILR records for the apprentice and records any payment adjustments needed using PMR records.
538. The new provider creates new ILR records for the apprentice.
539. If the apprentice is continuing with the same apprenticeship standard, then the Restart indicator (RES1) should be recorded on the new aim records.

540. The new provider must record the new negotiated price, taking into account any relevant prior learning.

12.4 Recording higher and degree apprenticeships

541. For Adult skills funded higher apprenticeships frameworks, the Funding model and Source of funding for HE component aims (such as prescribed HE aims) should be: Funding model code 35 and Source of funding code 105. All aims for apprenticeship standards are recorded using Funding model code 81 and Source of funding code 105.

542. Where the HE qualification being undertaken is not listed on the LARS database, for example for a foundation degree or degree awarded by an HEI, you will need to request that the learning aim is added into the LARS database.

543. To request HE learning aims for use within a SASE apprenticeship framework, please contact the [higher apprenticeship inbox](#) for a copy of the required request form. This form is also used to advise of the price of the qualification.

544. To request HE learning aims for use within an apprenticeship standard, please complete the form that is available on the following webpage:
<https://www.gov.uk/government/publications/individualised-learner-record-ilr-sources-of-data>

545. If you are a Further Education (FE) provider delivering HE learning aims as part of a higher or degree apprenticeship programme (identified using the field EngIPrscID in the LARS database) then you must return the Learner HE and Learning Delivery HE datasets. This requirement does not apply to Higher Education Institutions (HEIs), see Section 12.5 below for the data requirements for HEIs.

546. The HE datasets should be completed as accurately as possible and the use of default values should be avoided. Returning values such as null, 'not known' or 'not in HEFES population' may adversely affect HEFCE funding and should only be used where appropriate.

547. Certain higher education learning aims are exempt from the Section 96 validation rule that requires the learner to be aged 19 or over at the start of the aim. These learning aims may be identified in the LARS database with a value of IOP (Internal Other Provision) or IHE (Prescribed HE) in the LearningDeliveryGenre field1 in the EngIPrscID field, refer to the [Validation rules](#) for full details.

548. Additional information and guidance about higher and degree apprenticeships, and guidance for HEIs delivering higher and degree apprenticeships can be found on the [SFA: higher and degree apprenticeships](#) page on GOV.UK

12.5 Requirements for Higher Education Institutions (HEIs)

549. The following guidance does not apply to apprenticeships started on or after 1 May 2017. Requirements for HEIs delivering apprenticeships that start on or after 1 May 2017, refer to [Guidance for returning apprenticeships on the ILR from 1 May 2017](#).

550. HEIs must send an ILR return for higher and degree apprenticeships to the SFA for the following learners:

- 16-18 apprentices (for both apprenticeship frameworks and standards)
- 19+ apprentices on apprenticeship standards
For 19+ apprentices undertaking an apprenticeship framework, the ILR return is optional.

551. In addition to returning an ILR, all learners undertaking higher or degree apprenticeships must also be included within the HESA returns for 2016 to 2017.

552. There are different options available to you to create an ILR return:

1. Use your existing MIS software – you may need to procure additional functionality to do this
2. Use the ILR data entry tool provided by the SFA on [the Hub](#)
3. Work with a partner, e.g. an FE college
4. From 2016 to 2017, you can use a new facility provided by HESA which will create an ILR return from your HESA student record. Additional fields have been added to the HESA student record to enable an ILR return to be produced by HESA for you

553. Where a HEI is the lead provider for the apprenticeship programme, the ILR return must include all of the learning delivered as part of the programme, including the HE learning aims, any other qualifications, any non-regulated qualifications, etc.

554. HEIs do not need to complete the Learner HE and Learning Delivery HE datasets on the ILR for higher and degree apprenticeships: this data will be included on your HESA return. See the [Data Requirements for Higher Education Institutions \(HEIs\)](#) for further details.

Section 13 : Recording traineeships in the ILR

555. Traineeship programmes are composed of the following core elements: work placement, work preparation, and English and maths where required. Learners may also undertake other additional learning aims as part of the flexible element of the programme.

556. Further information about traineeships can be found in the EFA and SFA funding documents and in the [framework for delivery](#) document.

557. Traineeships are recorded on the ILR using the same programme structure as apprenticeships. They are composed of one programme aim and a number of component learning aims.

13.1 Traineeships for 16 to 18 year olds

558. These are funded using the EFA's funding per student methodology.

559. All learning aims must be recorded using Funding model code 25.

560. You must record the appropriate Source of funding based on your funding agreement:

- For providers who have a funding agreement with the EFA, the Source of Funding must be recorded using code SOF107 (EFA) in the Learning Delivery Funding and Monitoring fields.
- For providers who have a funding agreement with the SFA and do not have a funding agreement with the EFA, the Source of Funding must be recorded using code SOF105 (SFA) in the Learning Delivery Funding and Monitoring fields.
- Where a provider has both an EFA and an SFA funding agreement, the Source of Funding for traineeships for 16 to 18 year olds will be the EFA (SOF107).

561. The Work experience aim must be recorded as the core aim using Aim type code 5. All other aims must be recorded as a component aim using Aim type code 3. **If the work experience takes place across two teaching years then a separate learning aim is recorded in each teaching year. See the [EFA study programmes](#) section for details of recording EFA funded work experience.**

562. The Planned learning hours field should include the hours undertaken on approved qualifications including regulated work preparation qualifications, English and maths.

563. The Planned employability, enrichment and pastoral hours field should include the planned hours for work experience, all non-regulated work preparation and other non-qualification activities.

564. If the learner progresses, in the same teaching year, to an apprenticeship after completing their traineeship, the planned hours for the traineeship must continue to be returned. Learning hours undertaken within the apprenticeship are not recorded. Please see the [EFA Study programmes](#) section on page 92 for guidance on the planned hours fields.

13.2 Traineeships for 19 to 24 year olds

565. These are funded using the SFA's Adult skills funding model.

566. 19 to 24 year old learners who start a traineeship programme on or after the 1 August 2015 will be funded for their work experience and work preparation using a single combined funding rate which will be earned against the traineeship programme aim.

567. You should continue to record all learning aims that are part of the traineeship programme, including both the work preparation and work experience aims.

568. Continuing learners who started prior to 1 August 2015 will continue to be funded for the work experience and work preparation aims separately.

569. All traineeship programmes for 19 to 24 year old learners should have both work experience and work preparation aims.
570. All learning aims must be recorded using Funding model code 35.
571. The Source of Funding must be recorded using code SOF105 in the Learning Delivery Funding and Monitoring fields.
572. Learning Support Funding (LSF) is recorded on the programme aim for a traineeship. If the learner continues with English and maths aims after the traineeship programme is completed then the Learning support funding (LSF) will need to be transferred to either the English or maths aim. This should be done as follows:
- Set the 'Date applies to' for the LSF record linked to the Programme aim to the Learning actual end date of the programme aim.
 - Create a new LSF record for either the English or maths aim with a 'Date Applies from' of the following day.

13.3 Work experience

573. All traineeships must have a single work experience learning aim recorded on the ILR using one of the following generic learning aim references from the LARS database:

LEARNING_AIM_REF	LEARNING_AIM_TITLE	Available for:
Z0007834	Work experience/placement, 0-49 hrs	16-19 year olds only
Z0007835	Work experience/placement, 50-99 hrs	16-19 year olds only
Z0007836	Work experience/placement, 100-199 hrs	All traineeships
Z0007837	Work experience/placement, 200-499 hrs	All traineeships
Z0007838	Work experience/placement, 500+ hrs	All traineeships

574. For 16 to 18 year old traineeships, the work experience aim must be recorded as the core aim (Aim Type = 5).
575. For 19 to 24 year old traineeships, the work experience aim must be recorded as a component aim (Aim Type = 3).
576. If the learner undertakes multiple work placements during their traineeship, then they are not recorded as separate learning aims.
- For 16 to 18 year old learners, you should record one learning aim with the hours band that reflects the total number of hours delivered across all the work placements in the current teaching year.
 - For 19 to 24 year old learners, you should record one learning aim with the hours band that reflects the total number of hours delivered across all the work placements for the whole traineeship.
577. Details of each separate work placement are recorded in an additional work placement record that is linked to the work experience learning aim. Each work placement record includes the start and end date of the placement, and the employer identifier from the EDS system. All traineeship work placements must be with an external employer and the employer identifier must be recorded. See the [Work Placements](#) section on page 52 for further details and examples of how to record work placements.
578. The work experience employer should be identified before the learner starts a traineeship or within four weeks of starting. A learner can be recorded on the ILR as having started a traineeship even if the work experience and the employer are not yet finalised.

579. The Learning start date for the work experience aim must be the date on which the learner begins their work experience activity. This date may be after the programme start date if the work placement is planned to start in the future, or if the placement is yet to be finalised.
580. If the learner leaves the programme before starting their work placement, then the work experience aim should be removed from the ILR return. In this circumstance an alternative core aim must be identified for EFA funded learners and recorded as “withdrawn”.

13.4 Work preparation

581. Work preparation can consist of either a regulated qualification or a non-regulated learning aim.
582. 16 to 18 traineeships undertaking non-regulated work preparation should record one of the non-regulated work preparation aims from category E of [Appendix H](#).
583. 19 to 24 traineeships undertaking non-regulated work preparation should record one of the non-regulated work preparation aims from category A of [Appendix H](#).

13.5 Traineeships that spread across more than one teaching year

584. If the traineeship programme spreads across more than one teaching year then all of the learning aims (including the programme aim) that are part of the traineeship programme should be recorded in the following year’s ILR returns, including aims that were completed in the first teaching year.
585. If the learner is continuing with the English and/or maths elements of a traineeship in a second teaching year when the rest of the programme was completed in the first year, then the completed programme aim, component aims, and Destination and Progression data must continue to be returned in the following year’s ILR returns.

13.6 Recording completion, achievement and retention

586. The maximum duration for a traineeship programme is six months. The work-placement, work-preparation and flexible elements must be completed within this six-month period. **The programme aim for the traineeship should be closed after six months.**
587. If a learner does not complete the English and maths elements of the traineeship within 6 months then these can continue to be funded until they are completed. The traineeship programme aim and other component aims **must** be closed. The English and maths learning aims will remain open, no re-coding of these aims is required and they will continue to be recorded with a Programme type code of 24.
588. For learners who start a traineeship programme from 2015 to 2016, they have six months after the programme end date to demonstrate a positive destination and be able to record an Outcome for the programme of “Achieved”.
589. Where the programme is complete but the outcome is not yet known then the Learning actual end date should be entered and code 8 recorded in the Outcome field on the programme aim.
590. As soon as the provider has established that a learner has met the destination criteria for achievement, then this should be recorded on the ILR.
591. Traineeship programmes recorded as successfully achieved (Outcome = 1) should have both work experience and work preparation component aims.

592. The Achievement date must be recorded for all programmes that have an Outcome of “achieved” recorded. This is the date on which the learner has met the requirements for progression to an apprenticeship, job or further learning (see the EFA and SFA funding documentation for full details). For example: the achievement date is the date on which the learner has been in employment for 8 weeks or the date on which the learner met the funding qualifying period for an apprenticeship or further learning.
593. If the Achievement date is on or after 1 August 2016 and before 1 August 2017 then this must be reported in the 2016 to 2017 ILR returns (before R14) in order to earn achievement funding in the 2016 to 2017 year.
594. It is important that you establish the Destination of all learners who completed a traineeship programme in 2016 to 2017 before R14 in order to determine whether they have met the criteria for achievement funding in 2016 to 2017.
595. For traineeship programmes that start and finish in 2016 to 2017, the Achievement date must be within 6 months of the Programme actual end date to earn achievement funding.
596. Outcomes for the individual component aims should be recorded in the usual way.
597. If a learner progresses to an apprenticeship, see the [Learner transfers](#) section on page 62 for further information on how to complete the ILR.

13.7 Recording early leavers and transfers

598. Where an EFA funded learner transfers from a traineeship to a study programme with the same provider, the traineeship programme should be closed with a Withdrawal reason of ‘transfer’ (code 40). Any new aims being undertaken must be recorded, including a new core aim.

If the learner is continuing with English or maths aims that they have already started then these are left open and unchanged.

The Planned learning hours fields are updated.

599. Where an EFA funded learner transfers from a traineeship to an apprenticeship with the same provider, all aims in the traineeship programme are closed with a Withdrawal reason of ‘transfer’ (code 40).

The aims being undertaken as part of the apprenticeship programme are recorded using Funding Model code 35. The Funding adjustment for prior learning field must be completed if the learner is continuing with any aims from the traineeship programme. For example, if the learner is continuing with an English or maths aim that they have already started as part of the traineeship programme, then the aim must be recorded as closed and a new aim opened as part of the apprenticeship programme using Funding model code 35. The Funding adjustment for prior learning field must be completed.

600. Where a learner transfers from an SFA funded traineeship to an apprenticeship with the same provider, the traineeship programme is closed with a Withdrawal reason of ‘transfer’ (code 40). New aims being undertaken as part of the apprenticeship programme are recorded.

If the learner is continuing with English and maths aims that they have already started, then these are left open and unchanged.

13.8 Recording destination and progression information

601. A Destination and Progression record must be recorded for all traineeship learners at the end of the programme, even if the learner has not achieved a positive progression or you have been unable to contact the learner.

602. Destination and Progression data will be used in 2016 to 2017 to calculate and publish provider level outcomes for traineeships and to apply minimum standards of performance to providers.

603. ILR validation rules will be applied to all learners with a traineeship programme aim once an Outcome is recorded to ensure that there is a Destination and Progression record.
604. All traineeship programmes with a Learning actual end date prior to 1 August 2017 and a known outcome (i.e. the Outcome recorded on the programme aim is not code 8), must have a Destination and Progression record in 2016 to 2017. This may include Destination and Progression records with an Outcome collection date up to 19 October 2017.
605. If the learner completed their traineeship programme in 2015 to 2016 but is continuing with the English or maths in 2016 to 2017, you must continue to return the learner's Destination and Progression record in the 2016 to 2017 returns (including where the Outcome collection date is before 1 August 2016).

For example: *If a learner completes their traineeship programme on 25 February 2017, then the traineeship programme aim should be closed with an Actual End date of 25/02/2017 and an Outcome status of code 8.*

The provider contacts the learner after 6 months on 10 September and finds out the learner got a job on the 14 April and is still employed. They have met the achievement criteria of obtaining a job for 16 hours a week for 8 consecutive weeks within 6 months.

The traineeship programme aim can now be updated to record an Outcome status of code 1 and an Achievement date of 14 June (8 weeks from the start of the job).

A Destination and Progression record must be added with the following information:

- *Outcome type and code: EMP2*
- *Outcome start date: 14 April 2017*
- *Outcome end date: blank*
- *Outcome collection date start: 10 September 2017*

606. The tables below indicate how to record the Outcome fields in different scenarios, for learners who start from 2015 to 2016 onwards.

1. Learner completes the traineeship programme, achieves qualification aims but their destination is currently unknown

Aim	Start Date	Completion Status	Actual End date	Outcome	Achievement date	SFA Achievement funding	EFA Retention funding	Employment Outcome (19-24 only)
Programme aim	After 31/07/2015	Completed	Actual end date of programme	Learning activities complete but outcome not yet known	Not completed	No funding	100%	Not completed
Work Placement	On or after prog start date	Completed	On or before prog end date	Achieved	Not completed	No funding		Not completed
Work Prep	On or after prog start date	Completed	On or before prog end date	Achieved	Not completed	No funding		Not completed
English and/or maths (or other qualifications)	On or after prog start date	Completed	May extend beyond prog end date	Achieved	Not completed	Yes – 20% of qual aim		Not completed

2. Learner completes and achieves all learning aims and progresses to a job or apprenticeship or further learning

Aim	Start Date	Completion Status	Actual End date	Outcome	Achievement date	SFA Achievement funding	EFA Retention funding	Employment Outcome (19-24 only)
Programme aim	After 31/07/2015	Completed	Actual end date of programme	Achieved	Must be within 6 months of actual end date	Yes – 20% of single prog rate	100%	Not completed
Work Placement	On or after prog start date	Completed	On or before prog end date	Achieved	Not completed	No funding		Not completed
Work Prep	On or after prog start date	Completed	On or before prog end date	Achieved	Not completed	No funding		Not completed
English and/or maths (or other qualifications)	On or after prog start date	Completed	May extend beyond prog end date	Achieved	Not completed	Yes – 20% of qual aim		Not completed

3. Learner completes and achieves all learning aims but DOES NOT progress to a job or apprenticeship or further learning

Aim	Start Date	Completion Status	Actual End date	Outcome	Achievement date	SFA Achievement funding	EFA Retention funding	Employment Outcome (19-24 only)
Programme aim	After 31/07/2015	Completed	Actual end date of programme	Not Achieved	Not completed	No funding	100%	Not completed
Work Placement	On or after prog start date	Completed	On or before prog end date	Achieved	Not completed	No funding		Not completed
Work Prep	On or after prog start date	Completed	On or before prog end date	Achieved	Not completed	No funding		Not completed
English and/or maths (or other qualifications)	On or after prog start date	Completed	May extend beyond prog end date	Achieved	Not completed	Yes – 20% of qual aim		Not completed

4. Learner leaves traineeship early to progress to a job or apprenticeship or further learning

Aim	Start Date	Completion Status	Actual End date	Outcome	Achievement date	SFA Achievement funding	EFA Retention funding	Employment Outcome (19-24 only)
Programme aim	After 31/07/2015	Completed	Actual end date of programme	Achieved	Must be within 6 months of actual end date	Yes – 20% of single prog rate	100%	Not completed
Work Placement	On or after prog start date	Withdrawn	On or before prog end date	Not Achieved	Not completed	No funding		Not completed
Work Prep	On or after prog start date	Withdrawn	On or before prog end date	Not Achieved	Not completed	No funding		Not completed
English and/or maths (or other qualifications)	On or after prog start date	Withdrawn	May extend beyond prog end date	Not Achieved	Not completed	No funding		Yes – 10 % of qual aim

5. Learner leaves traineeship early but DOES NOT progress to a job or apprenticeship or further learning

Aim	Start Date	Completion Status	Actual End date	Outcome	Achievement date	SFA Achievement funding	EFA Retention funding	Employment Outcome (19-24 only)
Programme aim	After 31/07/2015	Withdrawn	Actual end date of programme	Not achieved	Not completed	No funding	50%	Not completed
Work Placement	On or after prog start date	Withdrawn	On or before prog end date	Not Achieved	Not completed	No funding		Not completed
Work Prep	On or after prog start date	Withdrawn	On or before prog end date	Not Achieved	Not completed	No funding		Not completed
English and/or maths (or other qualifications)	On or after prog start date	Withdrawn	May extend beyond prog end date	Not Achieved	Not completed	No funding		Not completed

Section 14 : EFA study programmes

607. EFA funded study programmes are recorded on the ILR using funding model code 25. A programme aim record (where Aim Type = 1) is not required for EFA funded study programmes unless the learner is doing a traineeship.

608. The 14-19 Diploma programme has now finished. There should be no 14-19 Diploma learning returned in the 2016 to 2017 ILR.

609. A study programme may be one of the following:

- **Vocational programme**
This could be a mixture of vocational qualifications and non-qualification activity (potentially but not exclusively work experience).
- **Academic programme**
These could be a mixture of academic qualifications and non-qualification activity (this could include work experience).
- **Mixed programmes**
These could be a mixture of vocational and academic qualifications and non-qualification activity (this could include work experience).

610. From September 2013, General Further Education (GFE) and Sixth Form colleges have been able to admit full-time 14 and 15 year olds and alternative provision census home educated 14 and 15 year olds with the costs being met by the EFA. These students should be recorded with a Learning delivery monitoring code of LDM320 (14-16 EFA Direct Funded Students) or LDM321 (14-16 Home Educated Students), which are recorded in the Learning Delivery Funding and Monitoring fields.

14.1 Planned hours fields

611. There are two fields on the ILR at learner level to collect the planned timetabled hours for the learner at the start of their study programme:

- **Planned learning hours:** This field should be completed with the total planned timetabled hours, for the learner for the year, to be spent on DfE approved qualifications only.
- **Planned employability, enrichment and pastoral hours:** This field includes all other planned, timetabled hours included in the study programme that are not included in the Planned learning hours field. The hours for non-regulated learning aims including work experience/placement aims (see [appendix H](#)) are recorded in this field.

612. These fields must be finalised and confirmed as correct within the funding qualifying period as defined in the funding documentation.

613. By the end of the qualifying period it is important to ensure that the planned hours reflect, as accurately as possible, the timetabled activity the student is planning to undertake for the duration of the academic year.

614. It is the total of these hours fields that are counted for funding.

615. The hours recorded should be the total the learner is planning to do in the academic year even if this exceeds the number of hours that will be funded, as this could inform future policy.

Changes to planned hours

616. Ordinarily this data should not be updated during the year. However, if a learner progresses to subsequent learning in the same teaching year, after completing all the activities on their original learning agreement or plan, the EFA has set out in their funding documentation exceptional circumstances in which providers may change the planned hours to reflect this additional learning.

617. If the learner progresses from a traineeship to an apprenticeship during the year, then the planned hours for the EFA study programme must continue to be returned. Learning hours undertaken within the apprenticeship are not recorded.

Learner withdrawals and transfers within the funding qualifying period

618. If the learner withdraws or transfers within the funding qualifying period, the following guidance should be followed:

- a) **Learner withdraws from all learning aims and leaves the provider**
 - Planned hours are left unchanged.
- b) **Learner withdraws from one or more learning aims but continues in learning with the provider**
 - Providers can include the hours timetabled up to the point of withdrawal if this makes a significant material difference to the learner's planned hours such that they would move from one funding band to another. Hours timetabled for after the date of withdrawal must be removed from the planned hours fields.
- c) **Learner transfers from one learning aim to another**
 - If the transfer of a student from one learning aim to another makes a significant material difference to their planned hours such that they would move from one funding band to another, hours timetabled up to the point of transfer may be retained in the overall planned hours calculation (please see table below).

	Include in planned hours	Remove from planned hours
First aim (transferred off)	Hours timetabled before transfer	Remainder of hours for year
Second aim (transferred onto)	Hours timetabled after transfer	N/A

Learner withdrawals and transfers after the funding qualifying period

619. No changes should be made to the planned hours fields if the learner withdraws or transfers from any or all of their learning aims after the funding qualifying period for the learner has passed.

Example

A learner starts a study programme on 1 September 2016 with a planned end date of 31 July 2018, a second aim is planned to start on 5 January 2017. The Planned learning hours and Planned employability, enrichment and pastoral hours fields are completed at the start of the teaching year with the total hours for all planned aims up to and including 31 July 2017.

In December 2016 the learner decides to withdraw from the second learning aim before it begins. The Planned learning hours and Planned employability, enrichment and pastoral hours fields are not updated to reflect this, as the funding qualifying period for the learner has passed.

14.2 GCSE qualification grades

620. The fields 'GCSE maths qualification grade' and 'GCSE English qualification grade' collect the highest examination grade awarded to the learner for a GCSE maths or English qualification as at the funding qualifying start period.

621. The only exception to this is for full-time learners who have **both**:

- Grade D in English Literature
AND
- Grade E or lower in English Language

In this circumstance, the English Language grade should be recorded in the GCSE English qualification grade field. These learners are not subject to the grade D requirement for condition of funding and may enrol on a stepping stone to meet condition of funding. Further details can be found here:

<https://www.gov.uk/guidance/16-to-19-funding-maths-and-english-condition-of-funding>

14.3 GCSE maths and English condition of funding

622. If a learner has met or is exempt from the GCSE maths or GCSE English condition of funding, you must record this in the Learner Funding and Monitoring (FAM) fields using type GCSE maths condition of funding (MCF) and/or GCSE English condition of funding (ECF) as applicable.

623. For 2016 to 2017, new codes have been added to these FAM types as below:

- MCF4: Learner has met the GCSE maths condition of funding by undertaking/completing a valid maths GCSE or equivalent qualification at another institution through collaboration with the home institution
- ECF4: Learner has met the GCSE English condition of funding by undertaking/completing a valid English GCSE or equivalent qualification at another institution through collaboration with the home institution

624. Refer to the EFA's funding documentation for further details of the condition of funding exemptions.

625. Information about overseas qualifications can be found from UK NARIC (www.naric.org.uk).

14.4 Recording a core aim

626. Every EFA funded study programme must contain a 'Core aim'. This must be recorded in the Learning Delivery Aim type field using code 5. The core aim is the substantive learning aim being undertaken in a study programme.

627. For academic study programmes, if the learner's qualifications are of the same size, for example 3 A levels, the provider must assign one of these qualifications as the core aim.

628. Should a learner withdraw from the core aim, the core aim should only be reassigned where the new core aim is clearly demonstrable to be a substantial and core component of the learner's study programme. If an alternative aim that meets these criteria cannot be identified, the withdrawn aim should remain as the core aim.

629. For academic study programmes where all aims within the programme are of equal size, there is no requirement to select another core aim should a learner withdraw from the original core aim. Please refer to the EFA funding documentation for a definition of academic and vocational programmes.

630. It is expected that providers will be able to identify the substantive learning aim for the learner at the start of their study programme. In exceptional circumstances when the core aim is unknown by the end of the funding qualifying period, then another aim should be designated as core until the substantive learning aim is decided upon and recorded. The Aim type should then be re-assigned. The core aim must be finalised by the end of the teaching year.

631. **For all non-traineeship EFA study programmes that continue across more than one teaching year:** if the core aim is completed in year one then this aim should not be returned in year two. A new core aim must be identified in year two.

632. For traineeship programmes that continue across more than one teaching year: if the core aim is completed in year one then this aim should continue to be returned in year two. A new core aim does not need to be identified in year two. All learning aims that are part of the traineeship programme must continue to be returned in year two, including the programme aim and any other aims that were completed in year one.

14.5 Recording High Needs Students

633. The Learner Funding and Monitoring code for High needs students (HNS1) should be completed for EFA funded students only where a local authority has actually paid element 3 'top-up' funding for a student whose agreed learning support costs are greater than £6,000. It must not be used in any other circumstances, for example, where costs are less than or equal to £6,000 or where the local authority has made no in-year contribution to the costs even if they are judged/agreed to be greater than £6,000.

634. Code HNS1 should also be completed for students whose agreed learning support costs are greater than £6,000 and who are fully funded by the local authority in 2016 to 2017. Learning aims for these students are recorded using Funding model code 99, 'No SFA or EFA funding for this learning aim'.

635. All EFA funded learners aged 19-24 who are recorded as being high needs students in the ILR must also have either a Learning difficulty assessment or Education Health Care (EHC) Plan recorded in the Learner Funding and Monitoring fields. From 1 September 2016, all 19-24 year old high needs students must have an EHC plan as LDAs cease to have a statutory role.

636. For learners who receive element 3 support funding of more than £19,000 the Learning support cost field must be returned. The total support costs for the student should be recorded in the field (element 2 + element 3).

637. See [Recording source of funding](#) on page 49 for further details on recording the Funding model and Source of funding for these learners.

638. Supported Internships must be recorded with the Learning aim code 'Z0002347'. You can find information for the correct recording of the Supported Internship in [Appendix H](#).

14.5.1 Additional guidance for special post-16 institutions

639. The ILR fields to be completed by special post-16 institutions (SPIs) during 2016 to 2017 can be found in the table for EFA funded learners on page 111. Where the student is undertaking a traineeship programme, refer to the tables for traineeship programmes on page 123.

640. The Learning support cost field must be completed for all high needs students. This field should contain the total learning support cost (element 2 + element 3) for the student for the year. This will ensure consistency of data reporting with FE institutions.

641. See the table below for additional notes about recording Learner Funding and Monitoring (FAM):

Learner FAM	Notes
Learner difficulty assessment	Use code LDA1 if the student has an LDA. Note LDAs cease as of 1 September 2016.
High needs students	Use code HNS1 for all high needs students (EFA funded only).
Education Health Care Plan	Use EHC1 if the student has an ECH plan.
Learner support reason	Required if the student has received support from the 16 to 19 Bursary Fund or residential support. If not applicable, leave blank.
Eligibility for EFA disadvantage funding	Use code EDF1 for students who have not achieved a maths GCSE (at grade A*-C) by the end of year 11 and/or EDF2 for students who have not achieved an English GCSE (at grade A*-C) by the end of year 11.

Learner FAM	Notes
GCSE maths condition of funding	Use where a student is exempt from or has met the maths and/or English element(s) of the condition of funding.
GCSE English condition of funding	
Free meals eligibility	Use code FME2 where a 16 to 19 year old student is eligible for and in receipt of free meals.

642. For EFA funded students, at least one aim must have AimType code 5 (core aim) and all other aims must have AimType code 4 unless the student is studying a traineeship.

643. All EFA funded high needs students use Funding model code 25. Students who are fully funded by the Local Authority or who are social care funded are **not** included on the ILR.

644. The Source of funding for all EFA funded high needs students must be code SOF107, unless the student is over the age of 25.

14.6 Recording work experience

645. 16-19 study programmes include a work experience element which must be recorded on the ILR using one of the following learning aim reference codes:

Learning Aim Reference	Learning Aim Title
Z0007834	Work experience/placement, 0 to 49 hrs
Z0007835	Work experience/placement, 50-99 hrs
Z0007836	Work experience/placement, 100-199 hrs
Z0007837	Work experience/placement, 200-499 hrs
Z0007838	Work experience/placement, 500+ hrs

646. Providers should record the aim with the hours band that reflects the total amount of external work experience being undertaken during the current teaching year only. This may take place in one or more work placements during the year.

647. Providers should amend their data before the final return of the year to ensure that only external work experience hours are recorded for the learner in the work experience learning aim selected. Note that the hours recorded in the Planned employability, enrichment and pastoral hours field are not affected by this change and must not be amended.

648. If the learner only undertakes internal work placements during the year, the learning aim used must be Z0007834; this represents zero external work placement hours.

Example, Learner has planned work experience consisting of three internal work placements. This is recorded using learning aim Z0007834 as shown below (dates have been excluded from the diagram):

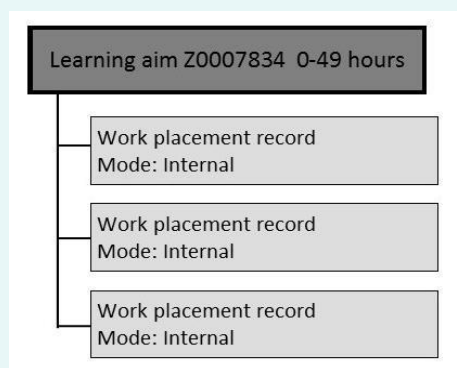

The learner then goes onto an external work placement consisting of 30 hours.
The new work placement record is added to the original aim:

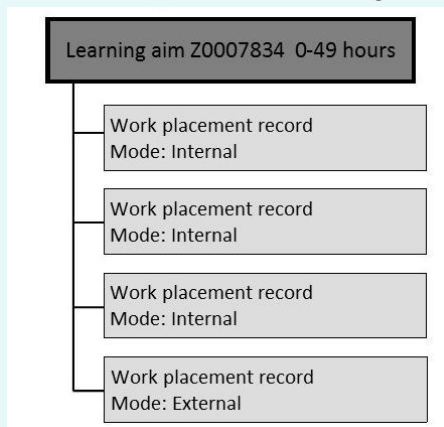

649. If during the year the learner undertakes an external work placement that exceeds the 0 to 49 hours band, then this should be recorded as a transfer onto a new work experience aim with the appropriate hours band and the corresponding work placement record.

Example If the above learner's new external work placement had a duration of 60 hours, then a new learning aim of 'Z0007835 50-99 hours' should be recorded and the corresponding work placement record attached:

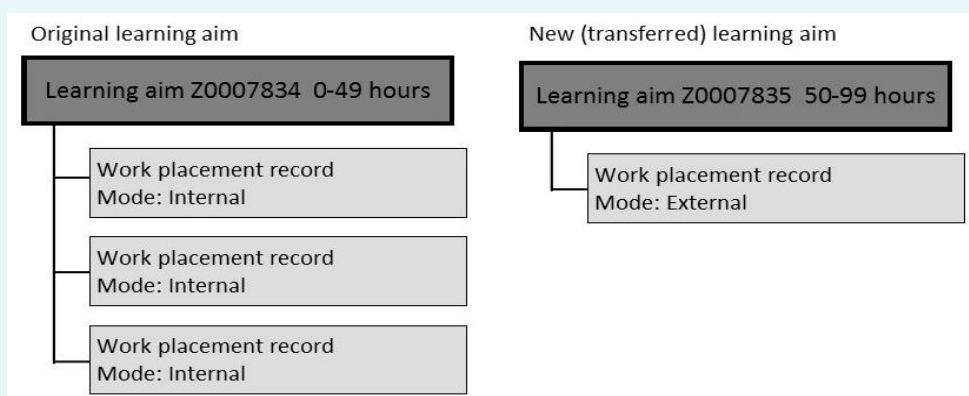

650. If a work experience placement takes place across the teaching year boundary of 31 July/1 August, then the learning aim recorded in 2016 to 2017 will have a Planned end date of 31 July 2017 and the hours band selected for the aim should only include the hours up to and including the 31 July 2017. A new aim with a Learning start date of 1 August 2017, will need to be recorded in the following year's ILR returns to record the hours remaining from 1 August 2017 onwards.

651. This guidance also applies to 16-19 traineeships, but not to 19-24 traineeships. See the [Traineeships](#) section on page 84 for further details of recording traineeships.

652. Work experience learning aims with a Learning start date in 2015 to 2016, that were recorded with a Planned end date after 31 July 2016 and that are continuing into 2016 to 2017, should be closed in the final ILR return for 2015 to 2016 using code 40, 'Learner has transferred to a new learning aim with the same provider', in the Withdrawal reason field. A new aim should be recorded for the learner in the 2016 to 2017 ILR with the correct hours band and work placement records for work experience that will take place in the 2016 to 2017 teaching year.

653. Where work experience is an essential and integrated part of a student's vocational qualification, such as a BTEC, a work experience learning aim is not recorded. The hours for the whole qualification including the work experience element are recorded in the Planned learning hours field.
654. The hours band selected for the learning aim does not affect EFA funding. The TOTAL work experience hours for the current year (both internal and external) must be included in the Planned employability, enrichment and pastoral hours field, and this is used for funding.
655. For some learners the work experience learning aim may be their core aim. It is expected that where work experience is the core aim that it will always be with an external employer.
656. If the learner has a core aim of work experience and they leave the study programme early to progress to a positive destination as detailed in the EFA funding regulations then the learner should record the work experience aim as completed to be classed as retained for funding purposes.
657. In addition to the work experience learning aim, providers must also record details of each work placement that is undertaken in the Work placement entity. See the [Work Placements](#) section on page 52 for further details.

Example 1

A learner on a two year study programme plans to do a total of 71 hours of work experience during the 2016 to 2017 teaching year. They will be undertaking an internal work placement for 6 weeks from 1 October 2016 until 14 November 2016, doing six hours each week and an external one week placement of 35 hours from 10-15 March 2017.

A single work experience learning aim must be recorded with the hours band that reflects the total amount of external work experience. In this case the aim recorded will be Z0007834: Work experience/placement 0-49 hours. The Learning start date of this aim is 1 October 2016 and the Planned end date will be 15 March 2017.

Two separate work placement records will also added, one for each placement detailing the start and end date of each placement and indicating whether the placement is internal or external.

The Planned employability, enrichment and pastoral hours field will include the total work experience hours for the year of 71.

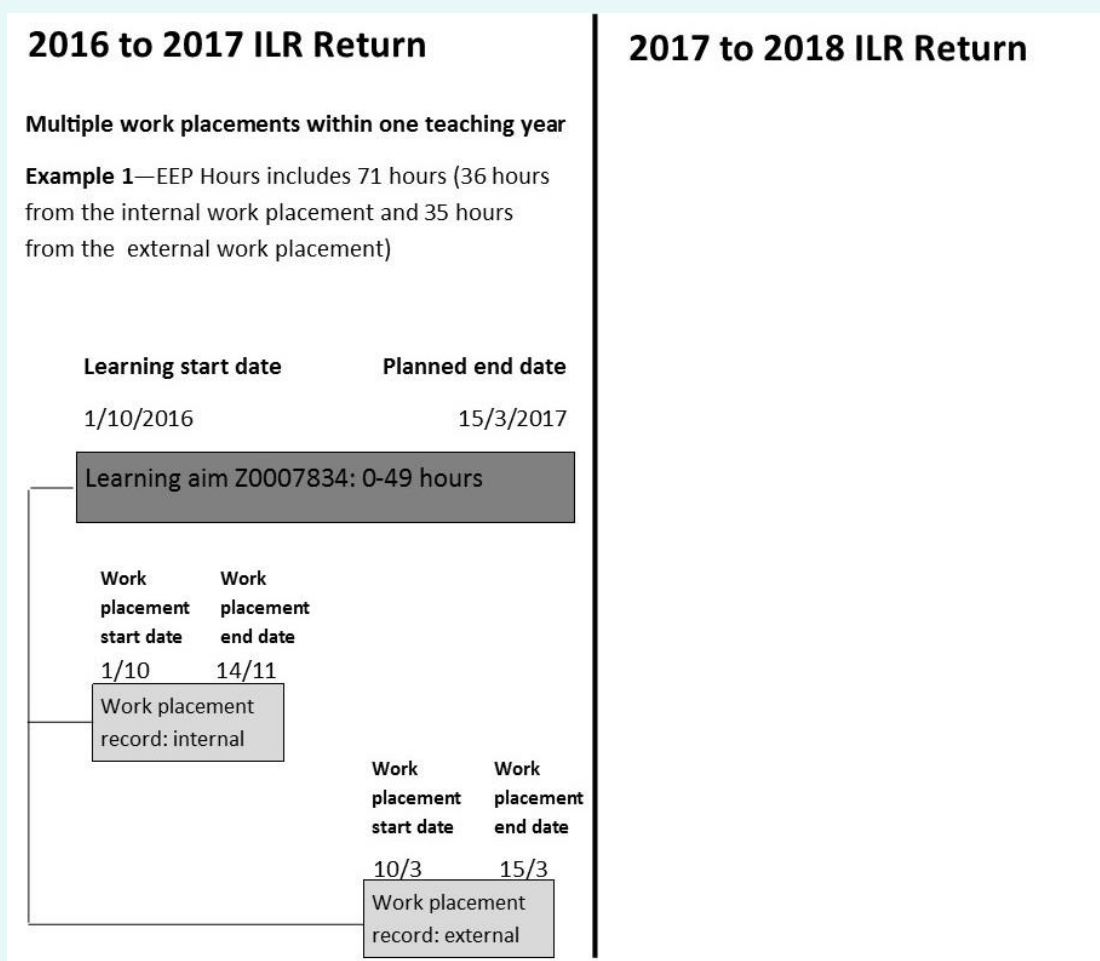

Example 2

A learner starts an external work placement on 15 July which is planned to end on 31 August 2017.

Because this placement spans the teaching year boundary, separate work experience aims and work placement records must be recorded in each teaching year, even though only one placement has taken place.

A learning aim of Z0007834: Work experience/placement, 0 to 49 hrs is recorded in the 2016 to 2017 ILR returns with a Learning start date of 15 July and Planned end date of 31 July 2017. This has a work placement record linked to it with the same dates.

A second learning aim of Z0007835: Work experience/placement 50-99 hours, will be recorded in the 2017 to 2018 ILR returns with a Learning start date of 1 August and Planned end date of 31 August 2017. This also has a work placement linked to it.

The Planned employability, enrichment and pastoral hours field for 2016 to 2017 will contain the work experience hours from 15 July until 31 July 2017. In 2017 to 2018 the field will record the remaining work experience hours from 1 August 2017 until 31 August 2017.

2016 to 2017 ILR Return

Single work placements that crosses two teaching years

Example 2—EEP Hours includes 40 hours from 15 July until 31 July.

Learning start date	Planned end date
15/7/2017	31/7/2017
Learning aim Z0007834: 0—49	
Work place-ment start date	Work place-ment end date
15/7	31/7
Work placement—external	

2017 to 2018 ILR Return

EEP Hours includes 80 hours from 1 August until 15 August.

Learning start date	Planned end date
1/8/2017	31/8/2017
Learning aim Z0007835: 50—99 hours	
Work place-ment start date	Work place-ment end date
1/8	31/8
Work placement—external	

14.7 Early leavers and transfers

658. For learners who withdraw from an EFA funding study programme in order to take up a traineeship, Supported Internship, or apprenticeship programme, their Destination and Progression data will be used to exclude the learner from DfE's completion and attainment measure.

Section 15 : Guidance on ESF funded learning aims

15.1 Recording ESF data in the ILR

659. For full details of the funding rules and requirements for the 2014 to 2020 ESF Programme, refer to the [2014 to 2020 ESF Programme funding rules](#) and [ESF funding rates and formula](#).
660. The data collection requirements for ESF funded learning are described in Table 12. The guidance below provides additional information to support data returns for the 2014 to 2020 ESF Programme.
661. For the ESF 2014 to 2020 Programme, all records for all learners who have received ESF funding as part of the current programme must continue to be returned for the duration of the ESF programme. This includes all Learner, Learning Delivery, and Destination and Progression records for learners who completed their learning aims in a previous teaching year. This is particularly important for the ZESF0001 aim which must always be included in the learner's record. Failure to return all aims for the learner (including closed aims) may result in a loss of funding that has already been claimed.
662. The Contract reference number in the Learning Delivery entity is used to identify all aims that belong to the same ESF contract. This field must be completed for all ESF funded provision. This number may also be referred to as the contract allocation number and will begin with 'ESF-'.

Learner data

663. ESF funded learners may be contacted as part of a sample survey to inform the effectiveness of the Programme. The contact preferences expressed for these learners will not apply in this circumstance. A telephone number should be supplied for all ESF funded learners to enable them to be contacted.

Learning delivery data

664. Every ESF funded learner must have a ZESF0001 aim recorded. This aim is used to indicate a learner start and assessment, and must continue to be returned for the duration of the ESF 2014 to 2020 Programme.
665. The appropriate learning aim reference from the LARS database must be recorded for each learning aim undertaken. The [Learning Aims search](#) function on the Hub allows you to search for regulated and non-regulated learning aims that are available for ESF activity. The learning aims must be valid under the ESF category in the LARS database in order to be recorded as ESF funded learning (Funding model = 70) in the ILR. See below for further details about recording non-regulated activity for ESF funded learning.
666. For ESOL learning aims, any required additional delivery hours should be recorded in the Additional delivery hours field.

Recording non-regulated learning activity

667. Non-regulated activity should be recorded using the class codes in [Appendix H](#) as specified in the [ESF funding rules](#). See [Recording non-regulated provision](#) (page 42) for more information about searching for class codes in the LARS database.
668. Non-regulated learning in a single sector subject area at a known level should be recorded using a class code from Category A. If the learning is across several sector subject areas then one of the codes for mixed sector subject areas from Category L should be used.
669. If the learning activity in sector subject area 14.1 (Foundations for Learning and Life) or 14.2 (Preparation for Work) has no defined indicative level, it should be recorded using a Category L class code. Otherwise, a code from Category A should be used.

670. Non-regulated English, maths or ESOL provision should be recorded using codes from Category B.

671. Work experience or work placement should be recorded using one of the codes from Category I.

Learner destination data and progression payments

672. You must record Destination and Progression data for all ESF funded and learners used as match for ESF. For learners used as match, the actual destination of the learner, where it is known, should be collected at the point the learner leaves learning. It is important that this data is reported accurately and completely.

673. Destination and Progression data is used to fund programme deliverables. Some ESF contracts will include progression funding, the criteria for this funding will depend on the contract.

674. The following ILR fields will be used to check if progression funding should be released:

- Contract reference number
- Learning aim reference
- Learning actual end date
- Outcome type
- Outcome code
- Outcome start date
- Outcome end date (if known: where the end date is not known the Outcome collection date is used)

675. Refer to the [ESF funding rules](#) and [ESF funding rates and formula](#) documents for further details about ESF Progressions and funding methodologies.

15.1.1 Returning ESF data and destination data

676. The ILR R01 and R02 returns of 2016 to 2017 must contain all current and prior ESF records (including both open and closed) including all Destination and Progression records. This data must then be returned in the R13 and R14 returns of 2015 to 2016, as illustrated in the diagram below.

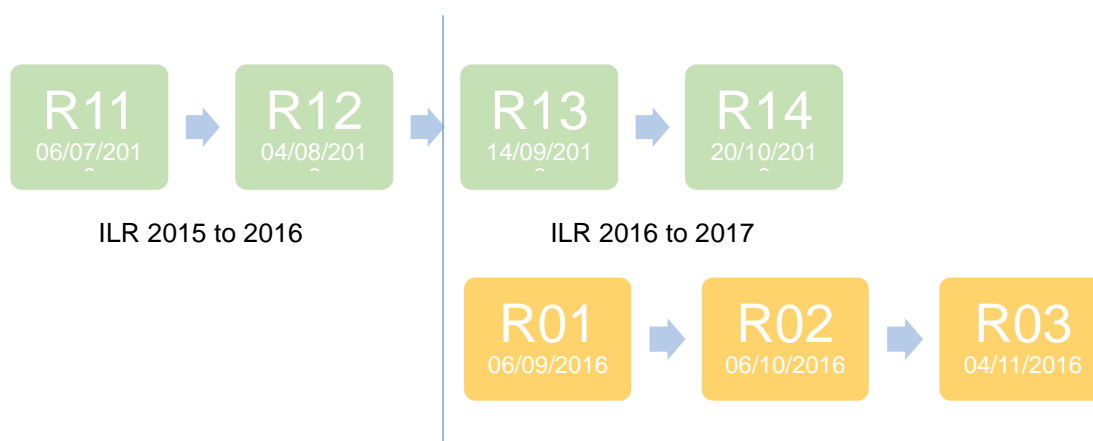

677. A Destination and Progression record must be returned for all closed ESF programmes within 3 months of the latest Learning actual end date.

678. When recording follow up Destination and Progression records, if the destination is the same (i.e. still in the same employment), the record's collection date must be updated. Otherwise, a new destination record must be returned.

679. ESF funded learners who leave the programme (all aims are closed) with a latest Learning actual end date prior to 1 August 2016 must have a Destination and Progression record returned in the 2015 to 2016 ILR prior to the close of R14 (20 October 2016).

15.2 ESF validation and eligibility checks

680. Learning activity delivered against an ESF contract will be checked against the eligibility criteria in the contract specification. The eligibility criteria will be applied based on the Learning start date of the completed ZESF0001 aim for that Contract reference number. You must maintain evidence as in the ESF funding rules and evidence of the eligibility checks carried out.

15.3 Supplementary data collection

681. Additional data required for the ESF Programme that is not collected through the ILR should be returned through the Supplementary Data collection.

682. Providers will need to create a supplementary data file (in csv format) and upload this to the Hub.

683. Additional information about the requirements for the supplementary data collection is published on GOV.UK via the [SFA: supplementary data collection](#) page.

15.4 Amending submitted data

684. Data must be correct at the time of claiming. The ESF Managing Authority have issued guidance stating that any changes must be made within the next quarter. Changes outside of this may lead to the recovery of funding.

15.5 Match Funding

685. As an ESF Opt-in Organisation, the SFA must match ESF funds contracted with money from the UK Government (that is, eligible mainstream programme funds).

686. The SFA is required to report this match funding and the associated learners within funding claims made to the ESF Managing Authority in England. When funds are identified as match funding, the learning activity and its associated funding become part of the ESF Programme and so must meet the same requirements as directly funded ESF activity.

687. Learning aims funded through the [Adult skills funding model \(including apprenticeship frameworks\)](#) may be used as match funding for the ESF Programme. Providers should expect learning aims to be used as match funding and keep data accordingly. The SFA will write to all providers confirming if they are being used as ESF match funding.

688. It is important that you return complete and meaningful data: values such as 'not known' or 'prefer not to say' should only be used in exceptional circumstances. This is particularly important for the following fields:

- Prior attainment [Learner entity]
- Employment status [Learner Employment Status entity]
- Household situation [Learning Delivery Funding and Monitoring entity]
- Outcome type and code [Destination and Progression entity]

Section 16 : Recording A and AS levels

689. The following guidance applies to all learners who start an AS or A level learning aim from 1 August 2015. It applies to all A levels.

What is changing?

690. From August 2015, new linear A levels were introduced with all external assessment at the end of the course. The AS has been decoupled from the A level, which means that AS marks will not count towards the A level. See <https://www.gov.uk/government/policies/reforming-qualifications-and-the-curriculum-to-better-prepare-pupils-for-life-after-school/supporting-pages/a-and-as-level-reform> and <https://www.gov.uk/government/collections/reform-of-as-and-a-level-qualifications-by-ofqual> for further information.

How will this affect ILR recording?

691. From August 2015 the use of A2 learning aims has been discontinued.

692. A2 learning aims are no longer available in the LARS database or recorded on the ILR, apart from where the learner started the A2 learning aim before 1 August 2015 and has not yet completed it.

693. In all cases, providers should accurately record the learning aim that a learner is working towards: either an AS or A level learning aim.

694. Where a learner takes an AS qualification and continues with further study to take the A level qualification in the same subject, both the AS learning aim and A level learning aim must be recorded.

695. A learner cannot be recorded on a new linear A level until the new A level has been introduced. If a new linear A level has not yet been introduced, then the learner must be recorded on the existing AS level or A level learning aim that is applicable.

Are there any funding implications?

696. For SFA funded A levels, if a learner undertakes both an AS and an A level in the same subject, the provider will need to record a funding adjustment on the ILR for the A level, to take into account the prior learning completed for the AS learning aim.

697. For EFA funded A levels, no funding adjustment is required, as these are funded through the EFA's funding per student methodology which uses planned hours for the year to determine funding levels.

AS and A levels that are financed by an Advanced Learner Loan

698. Learners will be able to apply for an Advanced Learner Loan for both AS and A levels to enable them to undertake up to 4 A levels funded with a Loan. Loans for A2 learning aims will be discontinued. Where a learner applies for a loan for an A level after sitting the AS in the same subject, the provider must reduce the fee for the A level to take into account the prior learning completed for the AS learning aim.

Recording AS level outcomes

699. AS qualifications in the subjects that have been decoupled from the A level will no longer be recorded as cashed or uncashed in the Outcome field of the ILR.

Transfers and withdrawals

700. Where a learner changes the AS or A level learning aim that they are working towards, or withdraws from the learning aim, this should be recorded in the usual way on the ILR - as detailed in Section 11.

Examples

701. The following examples illustrate how some different scenarios should be recorded, and assume that an AS qualification is studied over one year and an A level over 2 years:

Example A: Learner starts intending to do only an AS level. They complete the AS level as planned and do no further study in this subject in year 2

	Year 1	Year 2	Notes
Previous system	AS Level Subject 1		
From 1 Aug 2015	AS Level Subject 1		No change from previous approach

Example B: Learner starts intending to do only an AS level. Following the AS results they decide to take the A level in year 2

	Year 1	Year 2	Notes
Previous system	AS Level Subject 1	A2 Level Subject 1	
From 1 Aug 2015	AS Level Subject 1	A Level Subject 1	A2 level no longer recorded

702. The learner initially intends to do an AS level qualification; an AS learning aim is recorded on the ILR. After completing the AS aim, the learner decides to take the A level qualification in the same subject; an A level learning aim is recorded on the ILR.

703. For SFA funded learners, Funding adjustment for prior learning is required for this aim to take into account the previous learning completed for the AS learning aim.

Example C: Learner starts intending to do only an A level, and does not enter for the AS level. They complete the A level as planned

	Year 1	Year 2	Notes
Previous System	AS Level Subject 1	A2 Level Subject 1	
From 1 Aug 2015	A Level Subject 1		

Example D: Learner starts intending to do both an AS level and an A level. They complete both learning aims as planned

	Year 1	Year 2	Notes
Previous system	AS Level Subject 1	A2 Level Subject 1	
From 1 Aug 2015	AS Level Subject 1	A Level Subject 1	A2 level no longer recorded

704. The learner initially intends to do both an AS and A level qualification. An AS learning aim is recorded on the ILR. After completing the AS aim, an A level learning aim in the same subject is recorded.

705. For SFA funded learners, Funding adjustment for prior learning is required for this aim to take into account the previous learning completed for the AS learning aim.

Example E: Learner starts intending to do only an A level, but during year 1 decides to enter for the AS level as well

	Year 1		Year 2	Notes
Previous system	AS Level Subject 1		A2 Level Subject 1	
From 1 Aug 2015	A Level Subject 1			The A level learning aim is closed and transferred to an AS level
		AS Level Subject 1	A Level Subject 1	

706. The learner initially intends to an A level qualification; an A level learning aim is recorded on the ILR. During the academic year, the learner decides to also enter for the AS level; the A level learning aim is closed with Completion status code 3 (Learner has withdrawn) and Withdrawal reason code 40 (Learner has transferred to a new learning aim with the same provider).

707. The AS learning aim is recorded with a new learning start date. For SFA funded learners, Funding adjustment for prior learning must be recorded to take into account the previous learning completed for the A level learning aim.

708. Once the AS aim has been completed, an A level learning aim in the same subject is recorded. For SFA funded learners, Funding adjustment for prior learning is required for this aim to take into account the previous learning completed for the AS learning aim.

Example F: Learner starts intending to do only an A level, but during year 1 decides to transfer to the AS level. They do not go on to take an A level in this subject

	Year 1		Year 2	Notes
Previous system	AS Level Subject 1			
From 1 Aug 2015	A Level Subject 1			The A level learning aim is closed and transferred to an AS level
		AS Level Subject 1	Study for the AS level may continue into year 2 for some students	

709. The learner initially intends to an A level qualification; an A level learning aim is recorded on the ILR. During the academic year, the learner decides to transfer to the AS level; the A level learning aim is closed with Completion status code 3 (Learner has withdrawn) and Withdrawal reason code 40 (Learner has transferred to a new learning aim with the same provider).

710. The AS learning aim is recorded with a new learning start date. For SFA funded learners, Funding adjustment for prior learning must be recorded to take into account the previous learning completed for the A level learning aim.

Example G: Learner starts intending to do an AS level, and during year 1 decides to transfer to an A level and does not sit the AS level

	Year 1		Year 2	Notes
Previous system	AS Level Subject 1		A2 Level Subject 1	
From 1 Aug 2015	AS Level Subject 1			The AS level learning aim is closed and transferred to an A-level
		A Level Subject 1		

711. The learner initially intends to do an AS level qualification; an AS learning aim is recorded on the ILR. During the academic year, the learner decides to transfer to the A level; the AS level learning aim is closed with Completion status code 3 (Learner has withdrawn) and Withdrawal reason code 40 (Learner has transferred to a new learning aim with the same provider).

712. The A level learning aim is recorded with a new learning start date. For SFA funded learners, Funding adjustment for prior learning must be recorded to take into account the previous learning completed for the AS level learning aim.

Example H: Learner starts intending to do only an A level, and withdraws completely from this subject during year 1

	Year 1		Year 2	Notes
Previous System	AS Level Subject 1			
From 1 Aug 2015	A Level Subject 1			The A level learning aim is recorded as withdrawn

713. The learner initially intends to do an A level; an A level learning aim is recorded on the ILR. During the academic year, the learner decides to withdraw from the A level; the A level learning aim is closed with Completion status code 3 (Learner has withdrawn) and the relevant Withdrawal reason code.

714. See Section 11.7 for more details about recording learner withdrawals.

Section 17 : Recording household situation

715. This field should be used to record the household situation that applies at the start of each learning aim. This does not need to be updated if the situation subsequently changes.

716. The *ILR Specification for 2016 to 2017* contains the full definitions for this data.

717. For apprenticeship frameworks and traineeship programmes, the learner's household situation at the start of the programme should be recorded on the programme aim. It does not need to be collected and returned at the start of each individual component aim. **This data is not required for apprenticeship standards.**

718. The household situation must be collected for all ESF funded learning aims that started on or after 1 August 2015.

719. It must also be returned for match funding purposes for all Adult skills funded aims and Other SFA funded aims that started on or after 1 August 2015.

720. Data about a learner's household situation may be collected by obtaining the following signed self-declaration from the learner. This can be included in your enrolment form or similar document and can be captured electronically.

Please tick which of the following statements apply (one or more may apply):

- No member of the household in which I live (including myself) is employed
- The household that I live in includes only one adult (aged 18 or over)
- There are one or more dependent children (aged 0-17 years or 18-24 years if full-time student or inactive) in the household
- None of these statements apply

Or

- I confirm that I wish to withhold this information

Learner signature

Date.....

721. The table on the following pages gives details of which Household situation (HHS) FAM code to record if you are using the example self-declaration questions given above to collect learner household situation data.

Responses selected	HHS code
<ul style="list-style-type: none"> • No member of the household in which I live (including myself) is employed <input checked="" type="checkbox"/> • The household that I live in includes only one adult (aged 18 or over) <input type="checkbox"/> • There are one or more dependent children (aged 0-17 years or 18-24 years if full-time student or inactive) in the household <input type="checkbox"/> • None of these statements apply <input type="checkbox"/> <p>Or</p> <ul style="list-style-type: none"> • I confirm that I wish to withhold this information <input type="checkbox"/> 	HHS2
<ul style="list-style-type: none"> • No member of the household in which I live (including myself) is employed <input checked="" type="checkbox"/> • The household that I live in includes only one adult (aged 18 or over) <input checked="" type="checkbox"/> • There are one or more dependent children (aged 0-17 years or 18-24 years if full-time student or inactive) in the household <input type="checkbox"/> • None of these statements apply <input type="checkbox"/> <p>Or</p> <ul style="list-style-type: none"> • I confirm that I wish to withhold this information <input type="checkbox"/> 	HHS2
<ul style="list-style-type: none"> • No member of the household in which I live (including myself) is employed <input checked="" type="checkbox"/> • The household that I live in includes only one adult (aged 18 or over) <input type="checkbox"/> • There are one or more dependent children (aged 0-17 years or 18-24 years if full-time student or inactive) in the household <input checked="" type="checkbox"/> • None of these statements apply <input type="checkbox"/> <p>Or</p> <ul style="list-style-type: none"> • I confirm that I wish to withhold this information <input type="checkbox"/> 	HHS1
<ul style="list-style-type: none"> • No member of the household in which I live (including myself) is employed <input type="checkbox"/> • The household that I live in includes only one adult (aged 18 or over) <input checked="" type="checkbox"/> • There are one or more dependent children (aged 0-17 years or 18-24 years if full-time student or inactive) in the household <input checked="" type="checkbox"/> • None of these statements apply <input type="checkbox"/> <p>Or</p> <ul style="list-style-type: none"> • I confirm that I wish to withhold this information <input type="checkbox"/> 	HHS3
<ul style="list-style-type: none"> • No member of the household in which I live (including myself) is employed <input checked="" type="checkbox"/> • The household that I live in includes only one adult (aged 18 or over) <input checked="" type="checkbox"/> • There are one or more dependent children (aged 0-17 years or 18-24 years if full-time student or inactive) in the household <input checked="" type="checkbox"/> • None of these statements apply <input type="checkbox"/> <p>Or</p> <ul style="list-style-type: none"> • I confirm that I wish to withhold this information <input type="checkbox"/> 	HHS1 + HHS3

Responses selected	HHS code
<ul style="list-style-type: none"> • No member of the household in which I live (including myself) is employed <input type="checkbox"/> • The household that I live in includes only one adult (aged 18 or over) <input type="checkbox"/> • There are one or more dependent children (aged 0-17 years or 18-24 years if full-time student or inactive) in the household <input type="checkbox"/> • None of these statements apply <input checked="" type="checkbox"/> <p>Or</p> <ul style="list-style-type: none"> • I confirm that I wish to withhold this information <input type="checkbox"/> 	HHS99
<ul style="list-style-type: none"> • No member of the household in which I live (including myself) is employed <input type="checkbox"/> • The household that I live in includes only one adult (aged 18 or over) <input checked="" type="checkbox"/> • There are one or more dependent children (aged 0-17 years or 18-24 years if full-time student or inactive) in the household <input type="checkbox"/> • None of these statements apply <input type="checkbox"/> <p>Or</p> <ul style="list-style-type: none"> • I confirm that I wish to withhold this information <input type="checkbox"/> 	HHS99
<ul style="list-style-type: none"> • No member of the household in which I live (including myself) is employed <input type="checkbox"/> • The household that I live in includes only one adult (aged 18 or over) <input type="checkbox"/> • There are one or more dependent children (aged 0-17 years or 18-24 years if full-time student or inactive) in the household <input checked="" type="checkbox"/> • None of these statements apply <input type="checkbox"/> <p>Or</p> <ul style="list-style-type: none"> • I confirm that I wish to withhold this information <input type="checkbox"/> 	HHS99
<ul style="list-style-type: none"> • No member of the household in which I live (including myself) is employed <input type="checkbox"/> • The household that I live in includes only one adult (aged 18 or over) <input type="checkbox"/> • There are one or more dependent children (aged 0-17 years or 18-24 years if full-time student or inactive) in the household <input type="checkbox"/> • None of these statements apply <input type="checkbox"/> <p>Or</p> <ul style="list-style-type: none"> • I confirm that I wish to withhold this information <input checked="" type="checkbox"/> 	HHS98

Section 18 : Field collection requirements tables

722. The tables in this section list the fields that are collected for the different funding models.

The final tables in this section list details about the fields that are recorded for apprenticeship and traineeship programmes. Not all fields listed will need to be completed for all learners in all circumstances. Please refer to the *ILR specification* for the full details of the collection rules and requirements.

723. In addition to the Learner and Learning Delivery fields listed for each funding model, HE data may be required. See [section 9.11](#) for details of when to record HE data.

18.1 EFA funded learning

724. Some of the fields listed in Table 10 below are only required in certain circumstances. For field collection requirements for traineeship programmes, see section 18.7.3.

Table 10: EFA funded learning

Learner	Learner Employment Status
Learner reference number	Employment status
Learner reference number in previous year	Date employment status applies
Unique learner number	Employment Status Monitoring
Family name	Employment intensity indicator
Given names	Learning Delivery
Date of birth	Learning aim reference
Ethnicity	Aim type
Sex	Aim sequence number
LLDD and health problem	Learning start date
Accommodation	Learning planned end date
Learning support cost	Funding model
Planned learning hours	Subcontracted or partnership UKPRN
Planned employability, enrichment and pastoral hours	Delivery location postcode
GCSE maths qualification grade	Completion status
GCSE English qualification grade	Learning actual end date
Learner Contact	Withdrawal reason
Postcode prior to enrolment	Outcome
Current Address line 1 – 4	Outcome grade
Current Postcode	Learning Delivery FAM
Telephone	Source of funding
Email address	Restart indicator
Learner Contact Preference	Learning delivery monitoring
Restricted use indicator	Special projects and pilots
Preferred method of contact	HE monitoring
LLDD and Health Problem	Learning Delivery Work Placement
LLDD and health problem category	Work placement start date
Primary LLDD and health problem	Work placement end date
Learner FAM	Work placement mode
Learner difficulty assessment	Work placement employer identifier
High needs students	
Education Health Care Plan	
Learner support reason	
Special educational needs	
National learner monitoring	
Eligibility for EFA disadvantage funding	
GCSE maths condition of funding	
GCSE English condition of funding	
Free meals eligibility	
Pupil premium funding eligibility	

18.2 Adult Skills funded learning

725. Some of the fields listed in Table 11 below are only required in certain circumstances. This table does not include fields that are only required for apprenticeships or traineeship programmes, see Section 18.7 for these field collection requirements.

Table 11: Adult Skills funded learning

Learner	Learning Delivery
Learner reference number	Learning aim reference
Learner reference number in previous year	Aim type
UKPRN in previous year	Aim sequence number
Unique learner number	Learning start date
Family name	Original learning start date
Given names	Learning planned end date
Date of birth	Funding model
Ethnicity	Subcontracted or partnership UKPRN
Sex	Delivery location postcode
LLDD and health problem	Additional delivery hours
National Insurance number	Funding adjustment for prior learning
Prior attainment	Other funding adjustment
Planned learning hours	Employment outcome
Learner Contact	Completion status
Postcode prior to enrolment	Learning actual end date
Current Address line 1 – 4	Withdrawal reason
Current Postcode	Outcome
Telephone	Outcome grade
Email address	Learning Delivery FAM
Learner Contact Preference	Source of funding
Restricted use indicator	Full or co-funding indicator
Preferred method of contact	Restart indicator
LLDD and Health Problem	Learning support funding
LLDD and health problem category	Family English, Maths and Language*
Primary LLDD and health problem	Learning delivery monitoring
Learner FAM	Special projects and pilots
Learner difficulty assessment	National Skills Academy indicator
Education Health Care Plan	Work programme participation
Learner support reason	Percentage of online delivery
National learner monitoring	HE monitoring
Learner Employment Status	Household situation
Employment status	Date applies from
Date employment status applies	Date applies to
Employer identifier	
Employment Status Monitoring	
Self-employment indicator	
Employment intensity indicator	
Length of unemployment	
Benefit status indicator	
Previous education indicator	

*Only collected for Family English, Maths and Language learning aims delivered by through the Adult skills funding model

18.3 ESF funded learning

726. Some of the fields listed in Table 12 below are only required in certain circumstances.

Table 12: ESF funded learning

Learner	Employment Status Monitoring
Learner reference number	Self-employment indicator
Unique learner number	Employment intensity indicator
Family name	Length of unemployment
Given names	Benefit status indicator
Date of birth	Previous education indicator
Ethnicity	Learning Delivery
Sex	Learning aim reference
LLDD and health problem	Aim type
Prior attainment	Aim sequence number
Learner Contact	Learning start date
Postcode prior to enrolment	Learning planned end date
Current Address line 1 - 4	Funding model
Current Postcode	Subcontracted or partnership UKPRN
Telephone	Delivery location postcode
Email address	Additional delivery hours
Learner Contact Preference	Contract reference number
Restricted use indicator	Completion status
Preferred method of contact	Learning actual end date
LLDD and Health Problem	Withdrawal reason
LLDD and health problem category	Outcome
Primary LLDD and health problem	Outcome grade
Learner FAM	Learning Delivery FAM
Learner difficulty assessment	Source of funding
Education Health Care Plan	Restart indicator
Learner support reason (16-18 learners only)	Learning delivery monitoring
National learner monitoring	Special projects and pilots
Free meals eligibility (16-18 learners only)	Household situation
Learner Employment Status	
Employment status	
Date employment status applies	
Employer identifier	

18.4 Community Learning funded learning

727. Some of the fields listed in Table 13 below are only required in certain circumstances.

Table 13: Community Learning funded learning

Learner	Learning Delivery
Learner reference number	Learning aim reference
Unique learner number	Aim type
Family name	Aim sequence number
Given names	Learning start date
Date of birth	Learning planned end date
Ethnicity	Funding model
Sex	Subcontracted or partnership UKPRN
LLDD and health problem	Delivery location postcode
Planned learning hours	Completion status
Learner Contact	Learning actual end date
Postcode prior to enrolment	Withdrawal reason
Current Address line 1 - 4	Outcome
Current Postcode	Outcome grade
Telephone	Learning Delivery FAM
Email address	Source of funding
Learner Contact Preference	Restart indicator
Restricted use indicator	Community Learning provision type
Preferred method of contact	Learning delivery monitoring
LLDD and Health Problem	Special projects and pilots
LLDD and health problem category	
Primary LLDD and health problem	
Learner FAM	
Learner difficulty assessment	
Education Health Care plan	
National learner monitoring	

18.5 Advanced Learner Loans funded learning

728. Some of the fields listed in Table 14 below are only required in certain circumstances.

Table 14: Advanced Learner Loans

Learner	Employment status monitoring
Learner reference number	Self-employment indicator
Learner reference number in previous year	Employment intensity indicator
UKPRN in previous year	Length of unemployment
Unique learner number	Benefit status indicator
Family name	Previous education indicator
Given names	Learning Delivery
Date of birth	Learning aim reference
Ethnicity	Aim type
Sex	Aim sequence number
LLDD and health problem	Learning start date
National Insurance number	Original learning start date
Prior attainment	Learning planned end date
Planned learning hours	Funding model
Learner Contact	Subcontracted or partnership UKPRN
Postcode prior to enrolment	Delivery location postcode
Current Address line 1 – 4	Funding adjustment for prior learning
Current Postcode	Other funding adjustment
Telephone	Completion status
Email address	Learning actual end date
Learner Contact Preference	Withdrawal reason
Restricted use indicator	Outcome
Preferred method of contact	Outcome grade
LLDD and Health Problem	Learning Delivery FAM
LLDD and health problem category	Restart indicator
Primary LLDD and health problem	Advanced Learner Loans indicator
Learner FAM	Advanced Learner Loans Bursary funding
Learner difficulty assessment	Learning delivery monitoring
Education Health Care Plan	Special projects and pilots
Disabled students allowance (HE only)	HE monitoring
Learner support reason	Date applies from
National learner monitoring	Date applies to
Learner Employment Status	
Employment status	
Date employment status applies	

18.6 Non-funded learning

729. Some of the fields listed in Table 15 below are only required in certain circumstances. This table does not include fields that are only required for apprenticeship programmes, see Section 18.7 for these field collection requirements.

730. For Non-funded learning aims with a Source of funding of SOF108 (Community Learning) in the Learning Delivery Funding and Monitoring fields, see the Community Learning data requirements in Table 13.

Table 15: Non-funded learning

Learner	Learner Employment Status
Learner reference number	Employment status
Learner reference number in previous year	Date employment status applies
UKPRN in previous year	Employment status monitoring
Unique learner number	Self-employment indicator
Family name	Employment intensity indicator
Given names	Length of unemployment
Date of birth	Benefit status indicator
Ethnicity	Previous education indicator
Sex	Learning Delivery
LLDD and health problem	Learning aim reference
National Insurance number	Aim type
Prior attainment	Aim sequence number
Planned learning hours	Learning start date
Learner Contact	Learning planned end date
Postcode prior to enrolment	Funding model
Current Address line 1 - 4	Subcontracted or partnership UKPRN
Current Postcode	Delivery location postcode
Telephone	Completion status
Email address	Learning actual end date
Learner Contact Preference	Withdrawal reason
Restricted use indicator	Outcome
Preferred method of contact	Outcome grade
LLDD and Health Problem	Learning Delivery FAM
LLDD and health problem category	Source of funding
Primary LLDD and health problem	Restart indicator
Learner FAM	Community Learning provision type
Learner difficulty assessment	Learning delivery monitoring
Education Health Care Plan	Special projects and pilots
Disabled students allowance (HE only)	National Skills Academy indicator
National learner monitoring	HE monitoring

18.7 Field collection requirements by programme

731. Some of the fields listed in the tables below are only required in certain circumstances.

18.7.1 Apprenticeship framework programmes

732. The codes given in the following tables are indicative only and apply to Adult skills funded apprenticeship frameworks. The fields listed are required for non-funded apprenticeship frameworks.

733. For the field collection requirements for apprenticeship standards, refer to Table 19.

734. Providers and software suppliers should be aware that there may be situations where an alternative code applies to a particular learner.

Table 16: Apprenticeship frameworks: Learner record

Learner	Employment status monitoring
Learner reference number	Self-employment indicator
Learner reference number in previous year	Employment intensity indicator
UKPRN in previous year	Length of unemployment
Unique learner number	Length of employment
Family name	Benefit status indicator
Given names	Previous education indicator
Date of birth	Learning Delivery (see Table 17)
Ethnicity	Learning Delivery FAM (see Table 18)
Sex	
LLDD and health problem	
National Insurance number	
Prior attainment	
Learner Contact	
Postcode prior to enrolment	
Current Address line 1 – 4	
Current Postcode	
Telephone	
Email address	
Learner Contact Preference	
Restricted use indicator	
Preferred method of contact	
LLDD and Health Problem	
LLDD and health problem category	
Primary LLDD and health problem	
Learner FAM	
Learner difficulty assessment	
Education Health Care Plan	
National learner monitoring	
Learner Employment Status	
Employment status	
Date employment status applies	
Employer identifier	

Table 17: Apprenticeship frameworks: Learning delivery record

Field Name	Programme Aim	Component Aim
Learning aim reference	ZPROG001	Valid LARS code
Aim type	1	3
Aim sequence number	Sequence number of aim	Sequence number of aim
Learning start date	Start date of programme	Start date of aim
Original learning start date	Original start date if learner has returned after a break	Original start date if learner has returned after a break
Learning planned end date	Planned end date of programme	Planned end date of aim
Funding model*	35	35
Programme type	2: Advanced-level Apprenticeship 3: Intermediate-level Apprenticeship 20: Higher Apprenticeship – level 4 21: Higher Apprenticeship – level 5 22: Higher Apprenticeship – level 6 23: Higher Apprenticeship – level 7+	2: Advanced-level Apprenticeship 3: Intermediate-level Apprenticeship 20: Higher Apprenticeship – level 4 21: Higher Apprenticeship – level 5 22: Higher Apprenticeship – level 6 23: Higher Apprenticeship – level 7+
Framework code	Valid LARS code	Valid LARS code
Apprenticeship pathway	Valid LARS code	Valid LARS code
Subcontracted or partnership UKPRN	Not required	Valid UKPRN of subcontracted or partnership delivery provider if applicable
Delivery location postcode	Actual delivery location postcode	Actual delivery location postcode
Funding adjustment for prior learning	Not required	Percentage of the learning aim that is still to be delivered. Not returned if 100%.
Other funding adjustment	Not required	Not required unless requested by the SFA
Completion status	Relevant code	Relevant code
Learning actual end date	Actual end date of framework	Actual end date of aim
Withdrawal reason	Relevant code if the learner has withdrawn from the programme	Relevant code if the learner has withdrawn from the aim
Outcome	Relevant code for the outcome of the entire programme	Relevant code
Outcome grade	Not required	Relevant code from <i>Appendix Q</i>

*For non-funded apprenticeships, the Funding model is 99

Table 18: Apprenticeship frameworks: Learning Delivery Funding and Monitoring (FAM)

Description	FAM Type	FAM Code	Aim Type
Sources of funding*	SOF	105	Programme and component aims
Full/co-funding indicator	FFI	Relevant code	Programme and component aims
Eligibility for enhanced apprenticeship funding	EEF	Relevant code if applicable	Programme and component aims
Restart indicator	RES	Relevant code if applicable	Programme and component aims
Learning support funding	LSF	Relevant code if applicable	Programme aim only
Learning delivery monitoring	LDM	Relevant code if applicable	Programme and component aims
Special projects and pilots	SPP	Relevant code if applicable	Programme and component aims
National Skills Academy indicator	NSA	Relevant code if applicable	Programme aim only
Household situation	HHS	Relevant code	Programme aim only
Date applies from		Date FAM status is effective from, if LSF is returned	Programme aims only
Date applies to		Date FAM status is effective to, if LSF is returned	Programme aims only

*For non-funded apprenticeships, the Source of funding must not be 105

18.7.2 Apprenticeship standard programmes

735. The codes given in the following tables are indicative only and apply to funded apprenticeship standards. The fields listed are required for non-funded apprenticeship standards. For apprenticeship frameworks refer to Table 16.

736. Providers and software suppliers should be aware that there may be situations where an alternative code applies to a particular learner.

Table 19: Apprenticeship standards: Learner record

Learner	Learner Employment Status
Learner reference number	Employment status
Learner reference number in previous year	Date employment status applies
UKPRN in previous year	Employer identifier
Unique learner number	Employment Status Monitoring
Family name	Self-employment indicator
Given names	Employment intensity indicator
Date of birth	Length of unemployment
Ethnicity	Length of employment
Sex	Benefit status indicator
LLDD and health problem	Previous education indicator
National Insurance number	Small employer
Prior attainment	Learning Delivery (see Table 20)
Learner Contact	Learning Delivery FAM (see Table 21)
Postcode prior to enrolment	
Current Address line 1 – 4	
Current Postcode	
Telephone	
Email address	
Learner Contact Preference	
Restricted use indicator	
Preferred method of contact	
LLDD and Health Problem	
LLDD and health problem category	
Primary LLDD and health problem	
Learner FAM	
Learner difficulty assessment	
Education Health Care Plan	
Learner support reason	
National learner monitoring	

Table 20: Apprenticeship standards: Learning delivery record

Field Name	Programme Aim	Component Aim
Learning aim reference	ZPROG001	Valid LARS code
Aim type	1	3
Aim sequence number	Sequence number of aim	Sequence number of aim
Learning start date	Start date of programme	Start date of aim
Original learning start date	Original start date if learner has returned after a break	Original start date if learner has returned after a break
Learning planned end date	Planned end date of programme	Planned end date of aim
Funding model	81: Other SFA funding	81: Other SFA funding
Programme type	25: Apprenticeship standard	25: Apprenticeship standard
Apprenticeship standard code	Valid LARS code	Valid LARS code
Subcontracted or partnership UKPRN	Not required	Valid UKPRN of subcontracted or partnership delivery provider if applicable
Delivery location postcode	Actual delivery location postcode	Actual delivery location postcode
Funding adjustment for prior learning	Not required	For English and Maths aims only (if applicable): percentage of the learning aim that is still to be delivered. Not returned if 100%
Other funding adjustment	Not required unless requested by the SFA	Not required unless requested by the SFA
Completion status	Relevant code	Relevant code
Learning actual end date	Actual end date of programme	Actual end date of aim
Withdrawal reason	Relevant code if the learner has withdrawn from the programme	Relevant code if the learner has withdrawn from the aim
Outcome	Relevant code for the outcome of the entire programme	Relevant code
Achievement date	Date learner has met the criteria for achievement funding as set out in the funding rules. Only returned if the Outcome field has been recorded as 'Achieved'	Not required
Outcome grade	Not required	Relevant code from <i>Appendix Q</i>

Table 21: Apprenticeship standards: Learning Delivery Funding and Monitoring (FAM)

Description	FAM Type	FAM Code	Aim Type Required for
Source of funding	SOF	105	Programme and component aims
Eligibility for enhanced apprenticeship funding	EEF	Relevant code if applicable	Programme and component aims
Restart indicator	RES	Relevant code if applicable	Programme and component aims
Learning support funding	LSF	Relevant code if applicable	Programme aim only
Learning delivery monitoring	LDM	Relevant code if applicable	Programme and component aims
Special projects and pilots	SPP	Relevant code if applicable	Programme and component aims
National Skills Academy indicator	NSA	Relevant code if applicable	Programme aim only
Date applies from		Date LSF is effective from	Programme aims only
Date applies to		Date LSF is effective to	Programme aims only

18.7.3 Traineeship programmes

737. Some of the fields listed in the tables below are only required in certain circumstances.

Table 22: Traineeship programmes: Learner record

Learner	Learner Employment Status
Learner reference number	Employment status
Learner reference number in previous year	Date employment status applies
UKPRN in previous year	Employment status monitoring
Unique learner number	Self-employment indicator
Family name	Employment intensity indicator
Given names	Length of unemployment
Date of birth	Benefit status indicator
Ethnicity	Previous education indicator
Sex	Learning Delivery (see Table 23)
LLDD and health problem	Learning Delivery FAM (see Table 24)
National Insurance number	Work Placement (see Table 25)
Prior attainment	
Planned learning hours	
Learner Contact	
Postcode prior to enrolment	
Current Address line 1 – 4	
Current Postcode	
Telephone	
Email address	
Learner Contact Preference	
Restricted use indicator	
Preferred method of contact	
LLDD and Health Problem	
LLDD and health problem category	
Primary LLDD and health problem	
Learner FAM	
Learner difficulty assessment	
Education Health Care Plan	
National learner monitoring	

Table 23: Traineeship programme Learning Delivery data

Field Name	Programme Aim	Component Aim
Learning aim reference	ZPROG001	Valid LARS code
Aim type	Code 1	16-18 yr olds: Work experience aim = Code 5, Other aims = Code 3 19-24 yr olds: Code 3
Aim sequence number	Sequence number of aim	Sequence number of aim
Learning start date	Start date of traineeship programme	Start date of aim
Original learning start date	16-18 yr olds: Not required 19-24 yr olds: Original start date if learner has returned after a break in learning	16-18 yr olds: Not required 19-24 yr olds: Original start date if learner has returned after a break in learning
Learning planned end date	Planned end date of traineeship programme	Planned end date of aim
Funding model	16-18 yr olds: Code 25 19-24 yr olds: Code 35	16-18 yr olds: Code 25 19-24 yr olds: Code 35
Programme type	Code 24: Traineeship	Code 24: Traineeship
Subcontracted or partnership UKPRN	Not required	UKPRN of subcontracted provider if applicable
Delivery location postcode	Actual delivery location postcode	Actual delivery location postcode
Funding adjustment for prior learning	16-18 yr olds: Not required 19-24 yr olds: Percentage of the programme that is still to be delivered if learner has returned after a break in learning	16-18 yr olds: Not required 19-24 yr olds: Percentage of the learning aim that is still to be delivered if learner has returned after a break in learning
Other funding adjustment	16-18 yr olds: Not required 19-24 yr olds: Not required unless requested by the SFA	16-18 yr olds: Not required 19-24 yr olds: Not required unless requested by the SFA
Employment outcome	16-18 yr olds: Not required 19-24 yr olds: Not applicable. Job outcome payments cannot be claimed against the single programme rate.	16-18 yr olds: Not required 19-24 yr olds: Job outcome funding can be claimed for English, maths and flexible element learning aims where a learner has withdrawn from the learning aim to take up a job within the time period specified in the funding rules
Completion status	Relevant code	Relevant code
Learning actual end date	Actual end date of traineeship programme	Actual end date of aim. For English and maths aims this may be after the end date of the programme aim.
Withdrawal reason	Relevant code if the learner has withdrawn from the programme	Relevant code if the learner has withdrawn from the aim
Outcome	Code 8 when the traineeship programme is completed but the outcome is unknown Code 1 if the learner achieves the criteria for a positive destination Code 2 if the learner does not achieve the criteria for a positive destination	Code 1 if the learner achieves the learning aim Code 2 if the learner does not achieve the learning aim

Field Name	Programme Aim	Component Aim
Achievement Date	Must be completed for all programme aims with a status of "Achieved". The achievement date must be within 6 months of the Actual end date	Not completed
Outcome grade	Not required	Relevant code from <i>Appendix Q</i> , if applicable.

Table 24: Traineeship Learning Delivery Funding and Monitoring fields

Description	FAM Type	FAM Code	Aim Type
Source of funding	SOF	<i>16-18 yr olds</i> : Code 107 if the provider has an EFA funding agreement or Code 105 if the providers does not have an EFA funding agreement <i>19-24 yr olds</i> : Code 105	Programme aim and component aims (and core aim for 16-18 yr olds)
Full or co-funding indicator	FFI	<i>16-18 yr olds</i> : Not recorded <i>19-24 yr olds</i> : As per the funding rules	Programme and component aims
Restart indicator	RES	<i>16-18 yr olds</i> : Not recorded <i>19-24 yr olds</i> : Relevant code if applicable	Programme and component aims
Learning support funding	LSF	<i>16-18 yr olds</i> : Not recorded <i>19-24 yr olds</i> : Relevant code if applicable	Programme aim, component aim only when programme aim has ended (see paragraph 572)
Learning delivery monitoring	LDM	Relevant code if applicable	All aims where applicable
Special projects and pilots	SPP	Relevant code if applicable	All aims where applicable
National Skills Academy indicator	NSA	Relevant code if applicable	Programme aim only
Percentage of online delivery	POD	<i>16-18 yr olds</i> : Not recorded <i>19-24 yr olds</i> : Relevant code	Component aim only
Household situation	HHS	<i>16-18 yr olds</i> : Not recorded <i>19-24 yr olds</i> : Relevant code	Programme aim only
Date applies from	Date LSF is effective from, if LSF is returned		Programme aim, component aim only when programme aim has ended (see para 572)
Date applies to	Date LSF is effective to, if LSF is returned		Programme aim, component aim only when programme aim has ended (see para 572)

Table 25: Work Placement (recorded for the work experience aim)

Field Name	Description
Work placement start date	Start date of the work placement
Work placement end date	End date of the work placement
Work placement mode	Mode of the work placement, either internal or external
Work placement employer identifier	The employer identifier of the work placement

Destination and Progression record

738. A Destination and Progression record must be recorded for all traineeship learners at the end of the programme regardless of their achievement status

739. Where a provider has been unable to contact a learner to obtain information about their destination then code OTH3 should be recorded.

Field Name	Description
Outcome type and code	Type of outcome recorded e.g. job, further learning, apprenticeship
Outcome start date	Start date of the outcome
Outcome end date	End date of the outcome if there is one
Outcome collection date	Date the provider collected the information from the learner