



National Research and Development Centre
for adult literacy and numeracy

The three divides

**The digital divide and its relation to basic skills and
employment in Portland, USA and London, England**

Research report

John Bynner, Institute of Education, University of London;
Steve Reder, Portland State University; Samantha Parsons,
Institute of Education, University of London; Clare Strawn, Portland
State University



Leading education
and social research
Institute of Education
University of London

A short summary of this report is available as a separate document from the NRDC website: www.nrdc.org.uk/digitaldividesummary

Published by the National Research and Development Centre
for Adult Literacy and Numeracy

For information on alternative formats, or to give feedback on the content and accessibility of this publication, please contact:

Publications
NRDC
Institute of Education
20 Bedford Way
London WC1H 0AL
Telephone: +44 (0)20 7612 6476
Fax: +44 (0)20 7612 6671
Email: publications@nrdc.org.uk

© Crown Copyright 2010

Extracts from this publication may be used or reproduced for non-commercial, research, teaching or training purposes on condition that the source is acknowledged.

Contents

Executive summary	4
1. The comparative study	10
Background.....	10
The three divides	12
Research resources.....	13
Design issues	14
2. Comparing the three divides in Portland, USA and London and urban areas of the South East of England.....	18
Measurement of literacy and basic skills	18
Measurement of computer use and the digital divide	19
Measurement of work and the employment divide	20
Descriptive trends between 2000 and 2004	21
The three divides in summary.....	28
3. Modelling the relationships among the divides across time.....	29
Generic Model	29
Strategy for evaluating the model	31
Portland Model.....	32
Comparative Model.....	33
Comparative Model: Portland	34
Comparative Model: London.....	35
Conclusions: Portland and London Models reviewed.....	36
4. Elaborated London Model.....	38
Elaborated London Model: men and women compared	38
Elaborated London Model: including occupational status.....	40
Elaborated London Model: including occupational status and gender	41
5. Conclusions.....	44
References.....	47
Appendix 1: London and Portland longitudinal study details	50
Appendix 2: SEM statistics	53

Executive summary

The comparative study

The context of this comparative study was the rising importance of digital competence and access to computers as part of contemporary employability. In turn the 'digital' skills also connect with the basic skills of literacy and numeracy. There are consequently 'divides' between the 'haves' and the 'have nots' in relation to digital skills, basic skills and employment. Recent studies have consistently shown that individuals who have 'digital' access' have had more education and higher status occupations. Absence of those attributes, including digital competence increases the chances of social exclusion. The World Internet Project (WIP)¹ reports this divide within nations as well as cross-nationally. This study set out to investigate these divides in a North American and British context.

UK government policy is directed at giving the UK a lead position in the digital knowledge-based economy and includes new occupational standards for IT use, a new Level 1 certificate (ITQ for Life) and the development of a national strategy for ICT as a skill for life.

At the core of the processes creating the three divides is the educational record. Those on the positive side of each divide in both countries tend to show the higher levels of educational attainment. Those on the negative side tend to show the lowest levels, in which poor literacy proficiency is the crucial factor. A major concern is the increasing difficulty such young people often have in gaining and sustaining employment in the labour market, typically characterised in UK terms as six months or more between the ages 16 to 18 – 'Not in Education, Employment or Training (NEET)'.

The study capitalised on the availability of comparable longitudinal research resources relevant to the target populations – in the UK, the 1970 British Cohort Study (BCS70) and in Portland, Oregon, the Longitudinal Study of Adult Learning, (LSAL). The part of the BCS70 sample living in Greater London and the urban parts of the South East of England (referred to for convenience as the 'London study') was compared with the metropolitan area of Portland.

The Portland study comprises a representative sample of all adults proficient in English aged 18–44 in 1998 and living in Portland, who had failed to complete high school, oversampling for adults attending adult basic skills programmes. The combined sample has been followed up annually or biannually. The BCS70 sample comprises all 17,000-plus individuals born in Great Britain in a single week in 1970. The sample has been followed up at ages 5, 10, 16, 26, 30 and 34.

The fortuitous existence of follow-ups in 2000 and 2004 in both studies supported comparative study for comparable age-groups: 402 BCS70 cohort members aged 30 in 2000, who had also participated in the 2004 follow-up; 175 LSAL members aged 25–34 in the 2000 follow-up, who had also participated in the 2004 follow-

¹ WIP: www.worldinternetproject.net

up. To approximate the educational level of the LSAL sample, the BCS70 sample was restricted to those sample members with minimal or no qualifications (Level 1 or below) – most of whom had left school at the minimum age of 16 in 1986. Despite the inevitable loss of some sample members from the studies since they began and apart from the tendency for slightly more women than men and the more educated to stay in the study, both study samples remain representative of the starting populations).

Survey coverage in both studies included:

- tests of literacy proficiency (LP), available for 2000 and 2004 in LSAL² and 2004 in BCS70³
- measures of computer/internet access and use at both home and at work (ICT – information and communications technology). A number of alternative measures were available in both studies at both time points
- amount of employment (EMP), measured here as the number of weeks worked as a proportion of 104 weeks available over the two years prior to interview at each time point in each study
- occupational status (SOC – standard occupational status) measured from occupation of current job at the time of interview at both time points in both studies. Comparable occupational groups were derived despite variation in initial occupational classification schemes in the US and the UK.

There was also a wide range of demographic measures – gender, parents' education, number of children and ethnicity (US only) – to serve as statistical controls.

ICT and labour market context

Apart from differences in the forms of measurement used and data collected, there were contextual differences between the two locations. The Portland population had taken up, and maintained, high levels of ICT use earlier than in the case of the British sample, with only limited overall movement between the two time points and levelling off by 2004. In Britain the picture was one of a much larger rise in ICT access and use between 2000 and 2004 with convergence between the two countries by 2004.

Another distinctive feature of the Portland context was a recession in the local economy through most of our reference period that caused fluctuation and sorting in the labour market. The proportion who hadn't worked in the year prior to 2004 increased from 24 per cent to 28 per cent while there was a substantial increase in full-time workers. The issue then became one of examining the extent to which ICT and basic skills competence served as a form of protection against redundancy or enabled those made redundant to find other jobs. In London the situation was quite different throughout the whole period. The economy was continuing to expand and employers were prepared to lower their recruitment standards in order to fill the places available. In such a situation ICT competence

² Literacy was assessed using the US Test of Applied Literacy Skills (TALS) document literacy test. Since 1998 six waves have been completed.

³ Literacy (and numeracy) was assessed using a reduced form of the tests used in the 2002 Skills for Life National Baseline Survey (Williams et al. 2003).

is at a premium in gaining access to better kinds of job, not jobs per se as in Portland.

These labour market differences are reflected in some key sample characteristics. Both samples were well matched in terms of certain demographic attributes, such as gender, mean years of parents' education and mean age of leaving school. Notably, during the four-year period roughly 10 per cent of each sample achieved an educational qualification. In other ways, the samples were diverse. Thus although the proportions in skilled manual work were comparable between the two studies (one-fifth), compared with the Portland sample, twice as many of the London sample were in non-manual work (50 per cent) and half as many in unskilled manual work (28 per cent). Also, 45 per cent of the London sample had yet to become parents, compared with 30 per cent of the Portland sample. In addition, more than half the London sample were homeowners compared with less than one-quarter of the Portland sample.

Descriptive trends

The first stage of analysis was to compare computer use, changes in literacy proficiency and employment in the two countries over the four years between 2000 and 2004, i.e. when the BCS70 cohort members moved from age 30 to 34.

The amount of employment and ICT access and use – were measured in both surveys on both occasions.

While computer use *at work* rose steadily in Portland, computer ownership and use *at home* jumped dramatically in London with a 77 per cent increase between 2000 and 2004. Growth in computer use at home or at work levelled off and declined slightly in Portland, equalling that in London and the South East of England where a little over 80 per cent of the study population were using computers by 2004.

In conformity with labour market trends, there was clear evidence of fuller and more sustained employment in the London sample between 2000 and 2004 compared to Portland. Although about 20 per cent of the workforce was out of the labour market in both locations at both times, a much higher proportion of workers in the London sample worked consistently every week at both time points – 70 per cent compared with just 10 per cent in Portland in 2000. Moreover while the average proportion of time worked in the London sample was steady between 2000 and 2004, Portland area workers experienced a threefold increase in full-time employment.

The increase in full-time employment in Portland was coupled with a 90 per cent increase in the proportion of jobs using computers by 2004. In 2000, 57 per cent of those in a job in Portland were using computers at work in 2004, compared with 48 per cent in London.

The literacy proficiency comparison in the two locations was limited as it was only measured in BCS70 in 2004, when the cohort had reached age 34. However in the Portland study, where measures were obtained in both 2000 and 2004, there

was little evidence of change between the test scores overall for either men or women.

Structural equation modelling of the three divides in Portland and London

Structural equation modelling (SEM) was directed at assessing the extent and direction of the influence of computer use, literacy proficiency and time spent in employment measured in 2000 (Time 1) on the same variables measured in 2004 (Time 2), taking account of other variables serving as statistical controls: gender, parents' education, number of children and ethnicity (US only). The strength of all the relationships among the divide variables *between the two time points* was estimated by statistically significant regression coefficients and *at each of the two time points* by statistically significant correlation coefficients.

Such a model can be used to assess the direction of influence between the two time points. Thus if it is hypothesised that literacy proficiency in 2000 is more likely to lead to increased computer use in 2004 rather than computer use in 2000 leading to increased literacy proficiency in 2004, the regression coefficient will be significantly larger in the former case than in the latter case.

The modelling strategy was carried out in three stages:

- estimate the model first in Portland with the measures in the three divides at both time points – *Portland Model*
- estimate a reduced model with literacy proficiency deleted from 2000 (Time 1) to enable comparison with London – *Comparative Model*
- develop and estimate the model independently in the British sample, taking advantage of the larger sample size to test the model for men and women separately and extending it to include occupational status – *Elaborated London Model*.

Portland Model

The model showed clear relationships from employment and ICT use in 2000 (Time 1) to literacy proficiency in 2004 (Time 2), and a much more modest relationship from ICT use in 2000 (Time 1) to employment in 2004 (Time 2). Literacy proficiency in 2000 (Time 1) appeared to have no direct effect on employment or ICT use in 2004 (Time 2). There was evidence, however, of an indirect effect from parent's education and race (white) on literacy proficiency in 2000 (Time 1), which then predicted literacy proficiency in 2004 (Time 2). Literacy proficiency in 2000 (Time 1) then indirectly appeared to influence employment through its effect on ICT use.

These results suggest that exposure to ICT and employment boost literacy proficiency rather than the other way round. Exchanging the time spent on ICT at work for total time spent using ICT at home or at work produced stronger paths, suggesting that in the more depressed Portland labour market all ICT experience could be helpful in getting a job.

Comparative Model

In this case, although much the same pattern of relationships was evident in Portland and London, there were also differences. First, although the strength of the path between ICT use in 2000 (Time 1) and literacy proficiency in 2004 (Time 2) in the Portland Model remained much the same, the path between employment in 2000 (Time 1) and literacy proficiency in 2004 (Time 2) strengthened to twice its original size. Secondly, in London there was also a strong path between amount of employment in 2000 (Time 1) and ICT use in 2004 (Time 2), which was not seen in Portland. Finally, in the London model there was no significant relationship between ICT use in 2000 (Time 1) and amount of employment in 2004 (Time 2).

Thus the primary difference between the London and the Portland Models was in the effect of employment on literacy proficiency. Both the Portland and London models point to a positive effect of employment and ICT use on subsequent literacy proficiency. In the Portland Model, employment has a stronger effect than does ICT and in the London case ICT has the stronger effect.

Elaborated London Model

The next step in the analysis was to elaborate the London Model further, taking advantage of the larger sample size. Two extensions were evaluated: the first comprised testing the model separately for men and women; the second comprised replacing time in employment by another divide, occupational status, alongside the other divide measures: computer use and literacy proficiency.

Men and women separately

There were notable differences in the relationships between the men's and the women's models. For men the strongest relationships were between ICT use in 2000 (Time 1) and literacy proficiency in 2004 (Time 2) and amount of employment experienced in 2000 (Time 1) and literacy proficiency in 2004 (Time 2). All the other relationships were relatively weak. For women although the relationship between ICT use in 2000 (Time 1) and literacy proficiency in 2004 (Time 2) was replicated, this time it was accompanied by the relationship between amount of employment experienced in 2000 (Time 1) and ICT use in 2004 (Time 2).

From these results it appeared that, for women, employment appeared to provide a means of access to ICT, which in turn over time could then raise literacy proficiency. For men no such relationship was apparent.

Effect of occupational status

Occupational status in 2000 (Time 1) – as might be expected – predicted literacy proficiency and ICT use in 2004 (Time 2). However, in this case the effects were two-way (reciprocal) with the rise in ICT use in 2000 (Time 1) predicting rise in occupational status in 2004 (Time 2) and vice versa.

The two-way relationships were different for men and women. For women occupational status in 2000 (Time 1) predicted more strongly ICT use in 2004 (Time 2), whereas for men ICT use in 2000 (Time 1) predicted more strongly occupational status in 2004 (Time 2). For both men and women ICT use in 2000 (Time 1) continued to predict increased literacy proficiency in 2004 (Time 2).

Accordingly we conclude that the relationships of ICT with employment across time are different for men and women. In the case of men, computer use connects with higher status occupations, which themselves support literacy proficiency improvement. For women, many of whom are returning to the labour market after child rearing, the key route to literacy proficiency is through ICT, experience of which is more likely to be gained in high status occupations.

Conclusions

The main conclusions to be drawn from the analysis are:

- The more depressed labour market conditions in Portland placed a premium on ICT use at home or in the workplace for getting employment, whereas the effect of such ICT use in the more buoyant London labour market was more likely to be access to higher-level jobs.
- The digital divide was reducing more quickly in Portland than in London but a solid minority in both places still had little access to or use of ICT.
- Employment and ICT use support the development of literacy proficiency – hence enhancement of literacy proficiency is aided by time spent in employment and exposure to ICT. The evidence of effects in the other direction is much weaker, i.e. of improved literacy proficiency influencing the take-up of ICT or getting employment.
- From the London evidence it appears that ICT use is more likely for men to be associated with progression in employment. For women it is more likely to arise from engagement with the labour market particularly through high status occupations.
- Decline or stagnation in any of the competences reflected in the three divides increases the likelihood of marginalisation and exclusion reinforcing the case for such government initiatives as Train to Gain and expanded adult basic education provision.

1. The comparative study

Background

Technological transformation of employment since the 1970s and the consequent increasing globalisation of goods, services and labour markets have placed increasing pressure on employees for demonstrable competence in the basic skills of which literacy, numeracy and, ever increasingly, ICT skills are seen as central to employability (Levy and Murnane 2004). Yet the Confederation of British Industry (CBI) member employers report that currently their employees' poor literacy, language and numeracy skills have a negative impact on productivity (Dugdale and Clark 2008). The UK government has the goal of becoming a world leader among OECD countries in skills by 2020, when 95 per cent of the working age population are to possess at least functional literacy and numeracy (DIUS 2009).

Basic literacy especially supplies the foundations of the qualifications and further education and training that much contemporary employment demands. In addition, basic numeracy, also described as 'quantitative literacy', is considered vitally important in the modern economy as new forms of IT-based employment replace the unskilled work on which traditional industry depended. At the same time, it is well established that lack of literacy skills has social consequences reflected in another feature of the modern economy – the increasing marginalisation into casual jobs and unemployment of young people without the credentials that employers take to signify employability⁴.

In large areas of the contemporary labour market, the 'third' basic skill – ICT or *digital competence* – continues to gain increasing prominence. Without this skill, modern office work is largely inaccessible or heavily restricted for the people (often young women) seeking it. ICT competence links to numeracy, for which the demand has also been growing over the last 20 years, not least because it links increasingly to an office-based career (Bynner and Parsons 1997, Parsons and Bynner 2006). Moreover, lack of access to or competence in digital skills is increasingly an obstacle to taking advantage of learning and training opportunities that computers and the internet provide. Individuals who have 'digital' access to ICT have had more education and higher status occupations (Howard 2000, Clark 2008).

A consultation by the National Institute of Adult and Continuing Education (NIACE) in Britain established that in August 2007 only 61 per cent of households had access to the internet. The report (McNair 2009) quotes a Eurostat Survey in which it was reported that 40 per cent of women and 30 per cent of men were unable to carry out basic IT tasks such as moving a file or using copy and paste tools. In another report prepared for government leaders, it was noted that 60 per cent of employees in the UK had the technical proficiency they needed compared with 80 per cent in Poland and 75 per cent in Portugal (NIACE 2008). The World

⁴ See Sum et al. (2004) reporting analysis of US 'NALS' and OECD 'IALS' evidence.

Internet Project (WIP)⁵ reports this divide within nations as well as cross-nationally.

Literacy and numeracy skills are also not distributed evenly across industrialised countries. The Organisation for Economic Cooperation and Development (OECD), sponsors of the International Adult Literacy Survey (IALS), used a specially designed test to place members of population samples in 14 countries in one of four literacy levels. This showed for the USA and Great Britain over one-fifth at the lowest literacy level, three times the proportion in Sweden (OECD 1997, 2000).

In the interest of improved competitiveness and combating social exclusion, major initiatives have been taken to raise adult literacy levels. More recently the focus has been on raising numeracy and ICT access and use. In the UK this began with the work of the Moser Committee in 1997, who, over two years, assembled the evidence on the impact on society of poor literacy and numeracy performance and recommended a major programme of professional development and curriculum reform which was subsequently transformed into the top priority Skills for Life government programme, launched in 2001 (DfEE 1999, DfEE 2001).

Educational provision directed at raising literacy and numeracy levels among adults may be seen as part of a strategy to make good the deficiencies of education systems that fail to ensure that all individuals are fully equipped in adulthood with basic skills. Part of the reason for this failure lies in individual lives, especially where illness has prevented full participation in education from an early age or second language difficulties encountered on moving to a new country cause a child to fall behind (Snow and Strucker 2000). In other cases it is more a process of marginalisation within education rooted in poor home conditions and weak family support for education that teachers have failed to mitigate (Bynner and Steedman 1995, Parsons and Bynner 2007). Rather than education offering progression through different stages of achievement, a series of obstacles to achievement are encountered which the individual finds increasingly difficult to surmount. The consequence if this is that the child drifts away from mainstream educational provision, lacking the skills that underpin full access to the curriculum and failing to take advantage of the opportunities that the system offer for progression to further and higher education later on.

This is sometimes overlooked in the approach to adult basic skill provision, namely that many members of the target population are likely to view education as an alienating and demotivating experience rather than as a source of opportunity. Restoring motivation is likely to require new pedagogy in which information technology has been shown to have an important part to play (Mellar et al. 2004, Strawn 2006).

At one time gaps in basic skills proficiency were no bar to employment in Britain or the US. In Britain, until the end of the 1970s, as many as 65 per cent of young people left education at the minimum age of 16, most of whom moved straight into the large number of unskilled or semi-skilled jobs that existed then, regardless of any level of basic skills that they had. The attitude of employers in that era was 'what you need to know can be learned on the job'. Therefore all that

⁵ WIP: www.worldinternetproject.net

basically mattered for employability was willingness to work helped also by contacts in the local community through which job opportunities could emerge. The collapse of traditional industry and the digital basis of much modern employment placed an ever-growing demand for job applicants to have a range of personal attributes, including the 'basic' and digital skills.

In Britain the consequence of poor achievement, underpinned by lack of basic and digital skills, is one of the factors leading to young people leaving education at the earliest age, typically 16, without any qualifications. What follows may be a 'patchwork' labour market experience: in and out of jobs and spells of unemployment characterised as 'Not in Education, Employment or Training' (NEET). Basic skills and ICT courses in colleges or work places may supply a route back into education for some but usually not until their twenties.

In the USA the consequence of poor educational progress in the early years is likely to be failure to complete high school, with drop out at any age from 15 onwards depending on the minimum school leaving age, which differs from state to state. A second chance to achieve high school credentials comes through the General Education Development (GED) test. Rather than returning to high school to graduate in the conventional way or, in the case of immigrants, start high school from scratch, adults can attend adult education classes in preparation for the GED. The provision will often include significant literacy and numeracy components as core foundations of the curriculum to follow. The GED credential is meant to supply the student with a platform for the employment equivalent of the high school graduation diploma. In the case of first generation immigrants, the literacy problem is compounded by the need for first mastering English. Poor skills and lack of educational progression diminish chances in the labour market, making young people in this situation particularly vulnerable to exclusion from employment.

The three divides

In the contemporary labour market we therefore have evidence of three divides: the literacy proficiency divide, the digital divide and the employment divide.

- **Literacy proficiency** is the first and most fundamental divide. Although the numbers with 'very poor' ('Entry level' in UK terms) literacy are relatively small in both the UK and US populations, the numbers that exceed 8 per cent who are below the level of any recognised qualification in Britain represent formidable challenges (Bynner and Parsons 2006) – as do those well in excess of 20 per cent at IALS Level 1 or below. In the case of numeracy or 'quantitative literacy', the proportion with poor skills is so large that if anything it suggests that the strength of many economies, including those of the US and Britain, may be threatened by what can be seen as a major human capital deficit (OECD 1997, 2000).
- **The digital divide** sets apart those who are fully competent in the use of ICT from those who lack these skills or have no access to them through the use of computers and the internet either at home or their place of work.
- **The employment divide** reflects the marginalised opportunities; typically including regular spells of unemployment at one end of the labour market, as opposed to full-time, continuous and progressive working careers at the other.

Although there is good evidence to support the existence of these divides – loosely defined as a distribution of an attribute with accumulating negative (as opposed to positive) social and economic consequences for those at either end – there is little understanding of the relationship between them. Does enhancement of literacy competence precede enhancement of ICT competence or can the process work the other way round, with ICT providing a means of gaining access to literacy? At the same time, is it the case that ICT, as well as literacy proficiency, are both needed to get access to modern jobs, or is literacy still the main factor? Does employment boost both ICT competence and literacy proficiency?

Such questions demand the modelling of relationships between the key variables of interest controlling for other variables that could be confounded with them. For example is a young person's parents' low educational level generally the prime cause of their basic skills difficulty and later employment problems? What is the added effect of experience in the workplace?

Research resources

The study reported here capitalised on the existence of complementary US and British datasets, from which closely equivalent samples⁶ could be constructed (Bynner and Parsons 2008, Reder 2008).

The British data come from the 1970 British Cohort Study (BCS70) with originally 17,000 babies followed up on a number of occasions since their births in April 1970 – at ages 5, 10, 16, 26, 30 and most recently at age 34. Coverage includes key indicators of circumstances and experience relevant to the stage of life reached and ranges widely over family life, education, health and citizenship and included a comprehensive basic skills assessment at age 34. The study sample taken from the 1970 cohort (referred to for convenience as the 'London sample') comprised those cohort members classified as living in urban areas in London and the South East of England, who had left school with no qualifications or qualifications below Level 2⁷, usually at the minimum statutory leaving age of 16.

The US Longitudinal Study of Adult Learning (LSAL)⁸ is based in Portland, Oregon and comprises a representative sample of 934 individuals living in Portland in 1998, aged 18–44 who had failed to graduate from high school, i.e. had failed to complete the 12th grade (referred to throughout as the 'Portland sample'). They have been followed up on six occasions with the most recent survey taking place in 2006. In each follow-up all sample members had their basic skills assessed using the US Test of Applied Literacy Skills (TALS)⁹ as part

⁶ Both samples constitute sub-populations of the general adult population surveyed over a particular time period in particular places, but to avoid confusion between the statistics produced for them and those quoted for the whole of the local population, we refer to them as the 'study sample' or 'samples' throughout.

⁷ In June 1986 BCS70 cohort members were among the last set of 16 year olds to experience the two-tier examination system of General Certificate of Education (GCE) examinations with grades A–E or Certificate of Secondary Education (CSE) examinations with grades 1–6. Both GCE grades A–C and CSE grade 1 are Level 2 pass grades. In September 1986 this two-tiered system was replaced with the General Certificate of Secondary Education (GCSE) with grades A*–G. Grades A*–C are Level 2 pass grades.

⁸ See Reder (2009).

⁹ TALS is a standardised assessment of literacy using the ETS Test of Applied Literacy Skills. A technical discussion of this test can be found in the documentation of the 1992 National Assessment of Adult Literacy Survey. See Kirsch et al. (2000). To download a copy see <http://www.lsal.pdx.edu/instruments.html>. This instrument is from the same family of measures used in the IALS.

of an interview that also ranged over reading practices, employment experiences and ICT self-reported competence and application in a variety of settings. The Portland sample included sufficient numbers in the age range 28–35 in 2000 to match broadly those who had reached age 30 in 2000 in the BCS70. After removing those study members who had not completed both the 2000 and 2004 surveys, the matched sample comprised 175 individuals in Portland and 402 in London followed up over the same four-year period.

The matching succeeded for some sample member attributes, but was only partially successful for others (Table 1.1). Thus the male/female distribution, parental experience of education, sample members' average age when they left school and achievement level were well matched between the Portland and London samples. In contrast non-native English speakers (18 per cent), ever taken a literacy class and being a parent were strongly weighted towards Portland. Home ownership, on the other hand, was much more common in London than in Portland. Although a similar one in five of both populations worked in a skilled manual job, those in the London sample were much more likely to be in non-manual work and the Portland sample to be engaged in partly-skilled or unskilled manual work.

Table 1.1: Descriptive comparison (2000)

	BCS70	LSAL
Sample size	402	175
% female	54	52
% native English speakers		82
Mean years parent's education	10	12
Mean age left school	16	16
Mean years of education	11	10
% earning GED (US) or Level 2 (UK) between 2000 and 2004	10	7
% who are parents	55	70
% own home	53	22
% ever taken literacy class	2	63
% Non-manual work*	50	27
% skilled manual work*	22	20
% partly/unskilled manual work*	28	53

*reduced sample, those in work at time of interview

For more details of BCS70 and LSAL and the make-up of the matched sample – see Appendix 1¹⁰.

Design issues

Coverage

The matching was the result of much preliminary analysis before making a final commitment to this particular form of comparative design. A range of analyses of the data were carried out to test different ways of achieving equivalence and to

¹⁰ Also refer to www.cls.ioe.ac.uk/studies.asp?section=000100020002 for extensive information on BCS70 and www.lsal.pdx.edu/ for extensive information on LSAL.

identify deficiencies in the data. One problem in the London sample, for example, was that a basic skills assessment was not conducted at age 30 in 2000. In Portland comprehensive assessments were undertaken in both 2000 and 2004. Another problem was that operational definitions and measurement scales were not identical for key variables across the two countries. But nevertheless there was sufficient functional equivalence between the two datasets to make comparative analysis between them productive and worthwhile.

Educational equivalence

Precise equivalence between US and British educational achievement is difficult to establish. The US system assumes that every student will achieve high school graduation given the investment of the time and effort needed. The England and Wales education system operates through examinations taken at key ages, one of which, and probably the most important in relation to future destinations, is taken at age 16. In the case of BCS70, half the cohort expected to leave and did leave full-time education at the age of 16. Those who achieved the requisite qualification standard, Level 2 (at the time the General Certificate of Education [GCE] O-level grade A–C or Certificate of Secondary Education [CSE] Grade 1, subsequently replaced in 1997 by the General Certificate of Secondary Education [GCSE] grade A–C), were considered qualified for progression to further education. Further qualifications at advanced level, (A-level), usually taken at age 18, were needed to proceed to higher education. After extensive preliminary analysis to evaluate the effect of different cut offs, it was finally decided to view British cohort members who had failed to achieve Level 2, most of whom had left school at the minimum age of 16, as most closely equivalent to the Portland high school dropouts.

ICT take-up

Apart from differences in data collected in relation to all three divides, there were further contextual differences between the two locations. From investigations of the data, it was clear that the Portland population over the four years covered had taken up and maintained high levels of ICT use earlier than in the case of the London sample. In fact there was a levelling off of use in Portland reflecting near saturation of use, though there was still a residual gap (Strawn 2006). In Britain the picture was one of rising ICT access and use. In both LSAL and BCS70 data were collected about access to and use of computers and the internet.

Labour market context

Another distinctive feature of the Portland context was a recession in the local economy through most of our reference period that caused fluctuation and sorting in the labour market. The proportion who hadn't worked in the year prior to 2004 increased from 24 per cent to 28 per cent while there was a substantial increase in full-time workers. The issue here became one of examining the extent to which ICT and basic skills competence served as a kind of protection against job loss or enabling those made redundant to find other jobs.

In London and the South East of England the situation was quite different throughout the whole period. As part of general economic buoyancy across

Britain, the economy was continuing to expand and employers were prepared to lower their recruitment standards in order to fill the places available. In such a situation ICT competence has a premium attached in gaining access to better kinds of jobs.

During periods of unemployment, people in Britain have access to state benefits that enable them to manage economically. The US tends to be tougher, though again with great variation from state to state. Welfare benefits tend to be linked for both sexes to consistent attempts to gain employment, e.g. 'Welfare to Work' (Bright 2001). In Britain benefits were not conditional in this way and women, particularly with small children, from lower levels of the labour market, were more likely to stay at home looking after their children than seek to enter jobs that they did not want. A particular development of the British analysis was to examine gender differentiation with respect to the three divides in more detail. Numbers in the Portland sample unfortunately did not allow such fine-grained analysis, but early work showed that the gender effect was much weaker.

Analysis strategy

The analysis of the comparative data served two purposes. The first stage was to map descriptively similarities and differences in all features of the three divides and in the two national contexts. For a cross-national study with economic and policy development moving in different directions, this is an essential counterpart to statistical modelling, aiding the interpretation of disparate or unexpected findings. Only then can we begin to identify common processes across the two societies.

The second stage involved the use of structural equation modelling (SEM) (Kline 1998, Maruyama 1998) with the statistical package, MPlus¹¹, to test postulated causal processes, linking change over time in each of the three divide variables – literacy proficiency, ICT competence and employment. SEM supplies a means of testing such a model against observed data by estimating all possible influences (usually referred to as 'paths') between the variables involved ('saturated' model) or by 'constraining' certain paths to be zero, while others are estimated ('constrained model'). Estimates are in the form of regression coefficients (described as 'path coefficients') for which statistical significance can be established. Because of the relatively small sample sizes involved in this study, especially in Portland, only substantial path coefficients are likely to achieve statistical significance¹², supplying a stringent test of the model's validity. Of course, it is important to emphasise here that a 'good' fit of a structural equation model to the data does not prove causality, merely that the strength of relationships among variables and the direction of influence in the model can be used to support causal inference i.e. if a relationship between the specified variables cannot be established the causal hypothesis is ruled out.

In Chapter 2 we map out descriptively in much more detail the similarities and differences between the two study samples. In Chapter 3 we introduce the results

¹¹ For a description and discussion of the software see www.statmodel.com/

¹² The criterion adopted for statistical significance was $<.10$, which means that the odds in favour of the estimated value not differing by chance from zero is less than one in ten. This criterion is not strictly comparable between the Portland and London studies because of their differing levels of statistical power, which means that the main focus of comparison has to be the size of the estimated coefficients rather than their statistical significance alone.

of our modelling to test directionality of influence in structural equation models linking across the two time points, 2000 and 2004, the three divide variables: literacy, ICT and employment. In Chapter 4 we use the larger BCS70 dataset to elaborate the models further. The final chapter draws conclusions for the study as a whole and also considers some possible policy implications of the findings.

2. Comparing the three divides in Portland, USA and London and urban areas of the South East of England

The previous chapter described the background and context of the study and the broad features of the research design. In this chapter we describe in more detail the ways in which the three divides were operationalised, including the measures used in the two longitudinal studies. There are some differences in the descriptive data between Portland and London that reflect the different sample characteristics and analytic foci of the two studies. We also examine descriptively the detailed trends in the two samples and the populations to which they related in 2000 and 2004.

Measurement of literacy and basic skills

LSAL

Literacy proficiency is measured by repeated administration of the Document Literacy scale of the Test of Applied Literacy Skills (TALS) developed by the Princeton-based Educational Testing Service (ETS). The TALS assesses adults' abilities to extract and process written information within a variety of everyday functional materials using a constructed response format. TALS was used for several reasons. It is easy to administer and has known psychometric properties suitable for use in a panel study including interchangeable forms for repeat testing. Similar measures were used in the National Adult Literacy Survey, the International Adult Literacy Survey (IALS), and numerous state-level surveys of adult literacy, so that LSAL's proficiency measures are comparable to those used in a range of other studies. And, because literacy programmes do not use the TALS, programme participants in the LSAL sample will not have prior experience with it nor will they gain additional experience with it if they participate in programmes. Analysis of literacy proficiency in this paper uses the continuous TALS score.

BCS70

In BCS70, cohort members had their literacy skills objectively assessed in 2004. The instrument combined open-response paper-based questions previously used to assess BCS70 cohort members' functional literacy skills at age 21 with multiple-choice computer-based questions extracted from the 2002 Skills for Life Survey (Williams et al. 2003). Our focus here is on the multiple-choice questions. A total of 30 multiple-choice literacy questions made up the final assessment, of which only 20 were attempted by each respondent. All respondents attempted the first ten 'screening' questions (Entry 3) with those failing to answer at least six of these questions correctly (4 per cent) going on to answer ten easier (Entry 2) questions. The vast majority of respondents (96 per cent) who answered between six and ten screening questions correctly proceeded to a set of progressively

more difficult questions for which those on the lower track were allocated a score of '0' and those on the upper track a score of '1'. The reliability estimate of 0.87 for the 30 multiple-choice literacy assessment items surpassed the level generally considered acceptable for survey analysis purposes¹³. An overall score to reflect cohort members' performance relative to that of the whole population across the whole range of performance could therefore be reliably calculated. The maximum literacy score available from the multiple-choice questions is therefore within the range 16 to 30 for cohort members who were screened to progress to increasingly difficult questions and 0 to 15 for those who moved to the easier questions.

In addition to the objective assessment in 2004, the survey also included self-reported literacy difficulties developed from comparable questions used in earlier sweeps. An overall measure of difficulties with basic skills could be derived from three identical questions that were included in 2000 and 2004:

- Can you read and understand what is written in a magazine or newspaper?
- If you need to, can you write a letter to a friend to thank them for a gift or invite them to visit?
- When you buy things in shops with a five or ten pound note, can you usually tell if you are given the right change?

Measurement of computer use and the digital divide

LSAL

At each time point, the panel members were asked whether there was a computer in their home and whether they had used a computer since the previous interview. They were also asked about internet activities, including their use of the internet for email, chatting or instant messaging [IM], shopping, investigating personal interests, news, sports or weather and health information). These were used to form an activity scale scored zero if no internet activity or any of the above activities up to five if all activities were engaged in. In addition, frequencies of use (from never to everyday) of word processing, email and internet were collected at each time point. Respondents were also asked to estimate the number of hours per week they spent using the computer. Together, these indicators go beyond the simple use or not of computer technology by giving some context to skill level, intensity and range of use.

Similarly for computer practices at home, respondents were asked whether and how often they used email, the internet, or read a computer screen or entered information into a computer at work. A 'yes' response to any of these items, or if they reported computer training at work, identified cases who used a computer at work. The item 'entered information into a computer' could also be interpreted as using a computer screen interface for fast food ordering or cashiering, or other service positions such as call centre work.

¹³ For further details see Parsons, S. and Bynner J. (2006) 'Measuring Basic Skills for Longitudinal Study', *Literacy and Numeracy Studies*, Volume 14, No. 2, p.7-30.

BCS70

In 2000 and 2004 cohort members were asked whether they had a computer in their home and how often they usually used the computer. The 5-point scale went from 'never' to 'daily'. Computer users were asked what activities they used their computer for, including word processing, spreadsheets, downloading music, playing games, etc. Access to the internet via their computer was also asked about at both time points, with email and internet asked about separately. In 2004 a more comprehensive list of internet activities (e.g. shopping, paying bills, personal interests, etc) was also included.

Cohort members in work were also asked whether they used a computer at their work and if yes, how often they usually used it on a scale from 'less than once a week' to 'daily' in both 2000 and 2004. Computer users were asked what activities they used their computer for, including word processing, spreadsheets and email etc.

Measurement of work and the employment divide

LSAL

Data on the employment status at the time of the interview, whether or not respondents had worked in the four-year intervening period and an estimated number of weeks worked out of the previous 104, were collected at each wave. Work specific variables, such as hourly wage, limited the respondents to those who were working. Therefore, two measures of the employment divide were used: time spent in employment and occupational status or prestige of the current or most recent job.

Time spent in employment was measured as the proportion of weeks employed in the preceding two years, i.e. the number of weeks worked divided by 104, with no work coded as zero. This measure can be interpreted as the ability of a worker to remain employed over a period of time during which economic conditions fluctuate. A low proportion of weeks employed reflects vulnerability to unemployment while a high proportion indicates consistent employment.

Type of occupation was captured by coding the current or most recent job by standard US Department of Labor 'Duncan' categories¹⁴. These were re-coded into a smaller set that is roughly comparable to UK 'Registrar General Social Class' categories (described in next section below). Another measure of the employment divide, 'occupational prestige', is a scale that ranks type of work by status¹⁵. Prestige scores for the general population of the United States range from seven to seventy-eight compared with prestige scores ranging from nine to fifty-one for the LSAL population, which are skewed toward the lower one-third of the general population's range.

¹⁴ This is formally referred to as a socio-economic index (SEI) for all occupations. See Blau and Duncan (1967).

¹⁵ Occupational prestige scores were assigned based on the July 1998 cumulative Codebook developed by the General Social Survey at the University of Chicago.

BCS70

Current employment status at the time of interview together with a complete economic activity history back to the date of last interview has been collected in each wave of data collection since 1991. From this we can work out how long a cohort member has spent in each 'status' in any given period from the time they were 16, e.g. full-time education, unemployment, full- and part-time employment. To compare with the LSAL measure, amount of time in employment was again calculated as the proportion of weeks employed over the previous two years (104 weeks) prior to the 2000 and 2004 survey interview dates.

Type of occupation was derived from the main job held at time of interview in 2000 and 2004, coded in terms of the nine major groups of occupations specified in the UK Registrar General's Standard Occupational Classification (1990) for both 2000 and 2004¹⁶. As noted, the scale can be broadly aligned with the LSAL compressed occupational status scale.

Descriptive trends between 2000 and 2004

The descriptive statistics of the primary indicators of literacy, computer use and work are discussed below. We calculated the differences in percentages for a given attribute and mean test scores for the years 2000 and 2004 to reflect the changes that were taking place across the four-year period.

Literacy proficiency

Portland

Literacy proficiency did not change significantly over the four years for the sample being studied here. The mean score in both 2000 and 2004 was 280. There was no difference in literacy proficiency between genders. There was a significant ethnicity gap in literacy proficiency in 2000 with non-whites scoring 266, 23 points lower than whites, but little change beyond that point. No other differences in literacy measures were evident between groups or in trends over time.

London

We could not assess change in literacy score as literacy proficiency was objectively assessed only in 2004. The mean score achieved by the reduced sample without any, or only low level, qualifications living in London was 24.1, unsurprisingly lower than the 25.7 achieved by the whole BCS70 sample (n = 9,665). Twelve per cent of the reduced sample self-reported difficulties with reading, writing or number work in 2000, reducing to 8 per cent in 2004. However, men were significantly more likely than women to report difficulties in both 2000 (20 per cent to 6 per cent) and 2004 (13 per cent to 3 per cent).

¹⁶ The Standard Occupational Classification (SOC90) was introduced in the United Kingdom in 1990 as the first single classification of occupations. It was subsequently adopted by most government departments and agencies responsible for the production of occupationally classified information or the processing of occupational data. SOC90 is explicitly hierarchical in structure, grouping jobs according to the kind of work and the nature of the operation performed. It is comprised of unit groups at the most detailed level, which make up minor groups and (nine) major groups respectively. The major group structure brings together occupations which are similar in terms of the qualifications, training, skill and experience. SOC2000 has since replaced SOC90, but in this report we concentrate on SOC90.

Notably during the four-year period, roughly 10 per cent of each study sample had achieved a basic educational qualification (see Table 1.1).

Portland and London: Literacy compared

Literacy proficiency, although measured differently in the two studies (test in Portland, self-report in London), shows relatively little change in either location across the four years overall. This is to be expected for adults in this age range, as steep climbs in literacy achievement earlier in life level off in adulthood (Bynner and Steedman 1995) and the age related declines in late middle age had yet to appear (Reder 2008). Figure 2.1 shows higher white than non-white literacy proficiency scores in Portland and relatively little change in literacy across the four-year period. Figure 2.2 shows that in London there was an overall rise in perceived competence – ‘no reported difficulties’ – coupled with a substantial gap between men and women, which was narrowing across the period. Fewer women than men reported difficulties throughout.

Figure 2.1 BCS70 and LSAL literacy proficiency indicators

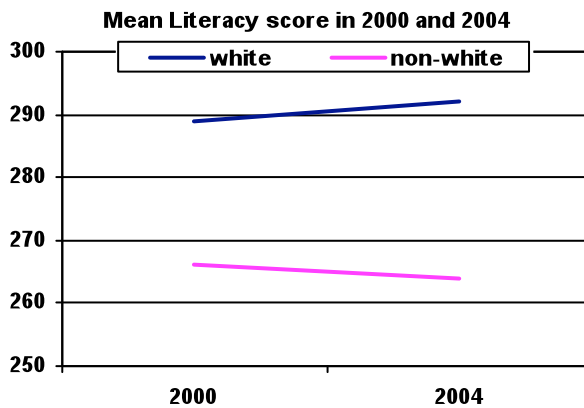
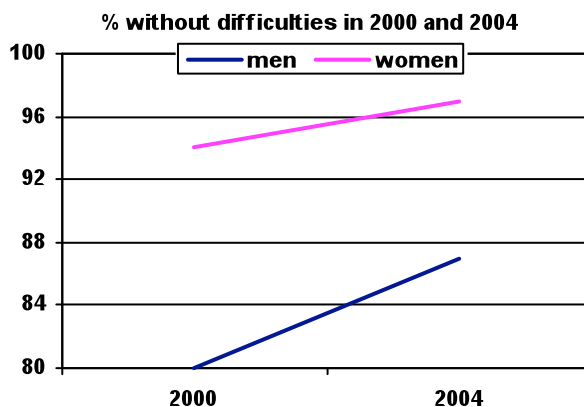

Figure 2.2: BCS70 not self-reporting skills difficulties 2000 and 2004



Computer and internet use

Portland

In 2000, 57 per cent of the sample had a computer in their home and 93 per cent had used a computer in the previous year. Table 2.1 shows that the trends for

change in technology use were mixed. More people had computers in their home in 2004 than in 2000, rising from 57 per cent to 65 per cent. However, fewer people were active computer users and those that did use computers did so for fewer hours per week than they did in 2000. While fewer people used the internet in 2004 – a drop of 9 per cent – those that did use it for a wider range of activities. The mean number of internet activities in which people engaged increased by 43 per cent. There were no differences between men and women in their use of a computer.

Table 2.1: Digital Divide indicators in LSAL

Item	N	Mean	Mean	% change
		values	values	
		and %	and %	
		2000	2004	
Computer in home	175	57%	65%	14*
Computer user	175	93%	83%	-11*
Hours per week (mean)	140	13.27	10.42	-21*
Use internet	175	66%	60%	-9
Internet activities (mean)	100	2.71	3.88	43*
Word processing	140	43%	37%	-14
Any computer use at work (of workers)	109	.30	.57	90*
Email and internet at work (of workers)	96	39%	50%	25.5*

Breaking down some of the figures further, in 2000, 73 per cent of non-whites had a computer in their home, compared to 51 per cent of whites, and used the computer nearly seven hours a week more than whites. The changes between 2000 and 2004 on these two items were also different; computer ownership increased to 69 per cent for whites while computer ownership for non-whites dropped to 66 per cent. Hours per week for non-whites' computer use dropped by 47 per cent (9 hours) while increasing by slightly over an hour for whites. Conversely, average internet use for non-whites increased from 62 per cent in 2000 to 71 per cent in 2004 while internet use among whites dropped 15 points, from 68 to 53 per cent.

Among those in work, computer use at work and specific use of a computer for email and internet access at work both increased between 2000 and 2004.

London

As with the Portland sample, Table 2.2 shows that more BCS70 members had computers in their home in 2004 than in 2000, increasing from 43 per cent to 76 per cent in London. However, only 36 per cent actually used their home computer in 2000. By 2004, more people had become active users with 76 per cent now using their home computer and 83 per cent using a computer at home or work. Women were more likely to be computer users in 2004 (79 per cent men, 86 per cent women). Use of a computer at home or work for word processing also increased between 2000 and 2004 (35 per cent to 50 per cent). Women were more likely than men to use a computer for word processing at both time points, more so in 2004 (44 per cent men, 54 per cent women).

As more had and used a computer, it is not surprising that computers were also being used more often. Ten per cent of the BCS70 sample used their computer on a daily basis in 2000, increasing to 23 per cent in 2004. Men were slightly more likely than women to be daily users in both 2000 (12 per cent to 7 per cent)

and 2004 (28 per cent to 19 per cent). On a scale ranging from 0 (non-user) to 4 (daily computer user) the mean score increased significantly from 0.95 in 2000 to 1.97 in 2004. However, it is important to remember that although the increase in access to and use of computers had been considerable between 2000 and 2004, around one in five (23 per cent men, 16 per cent women) of those with below Level 2 qualifications did not have a computer in their home in either 2000 or 2004.

Access to the internet (via a computer) at home or at work had similarly increased between 2000 and 2004, in fact more than doubling. Thirty-one per cent had access to the internet in 2000 compared with 70 per cent in 2004. Differences between men and women were not significant.

Whether a computer was used at work was asked only of cohort members *currently* employed at time of interview in 2000 and 2004. Computer use in work among this group of respondents increased during the four-year period (42 per cent to 48 per cent). Although more women than men used a computer at work in 2000 (37 per cent men and 46 per cent women) and 2004 (46 per cent men and 51 per cent women), the differences were not statistically significant. There was also an increase in the use of a computer at work specifically for accessing the internet or email between 2000 and 2004.

Table 2.2: Digital divide indicators in BCS70

Item	N	Mean values and % 2000	Mean values and % 2004	% change
Computer in home	399	43%	76%	77*
Computer user at home	399	36%	76%	111*
Computer user – home or work	399	53%	83%	57*
How often use at home (never to daily 0–4) (mean)	396	0.95	1.97	107*
Word processing (home or work)	399	35%	50%	43*
Internet user (via PC)	399	31%	70%	126*
Computer user at work (in work at 30 or 34) ¹	338	42%	48%	14*
How often use at work: never to daily 0–4 (in work at 30 or 34)(mean) ¹	338	1.58	1.77	12
Use email and/or web at work: range from neither to both 0–2 (in work at 30 or 34) (mean) ^{**}	338	0.39	0.60	54*

*Statistical significance, $p < .10$. **in work at time of interview

Portland and London: Computer use compared

Indicators of changes in the digital divide in Portland and London are shown in the bar graphs of Figure 2.3 for computer use at home and at work and internet use. While computer use at home barely changed in Portland using computers at work shot up. In London computer use and internet use at home rose most, while computer use at work barely changed. By 2004, growth in computer use and internet use had levelled off and declined slightly in Portland, equalling that in London with a little over 80 per cent of the sample using computers by 2004. Computer ownership and use of the internet rose in London compared with Portland by about 10 per cent. Thus despite the different trends in the two locations, the digital divide appeared to be equalising, with London, if anything,

pulling ahead in ownership and use of computers and the internet. The main difference in Portland's direction – probably reflecting local labour market differences – was that more people in Portland were doing jobs involving the use of computers.

Figure 2.3 Comparative BCS70 and LSAL digital divide indicators

Figure 2.3a: LSAL Computer use 2000 and 2004

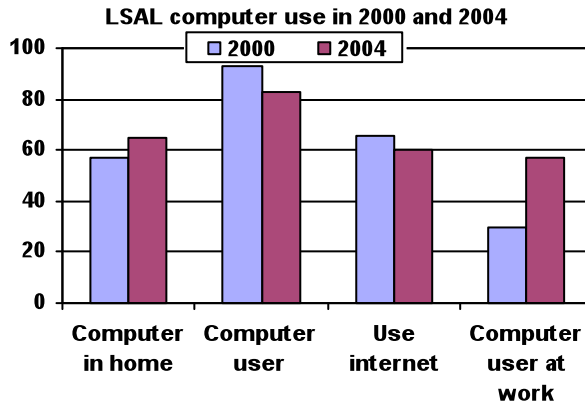
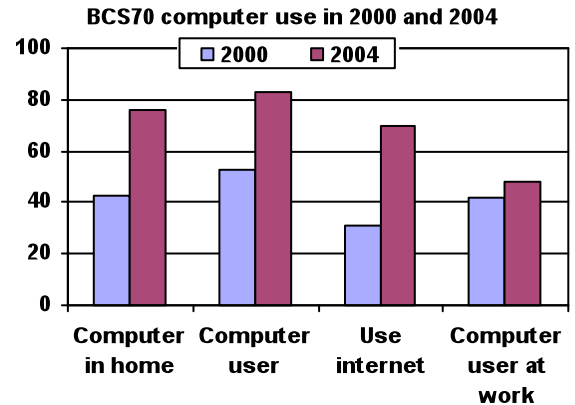

Figure 2.3b: BCS70 Computer use 2000 and 2004



Employment

Portland

About three-quarters of the sample had worked in the 12 months prior to 2000, a percentage that had not changed significantly by 2004 (Table 2.3). However, the proportion of weeks spent in employment increased significantly from 74 per cent in 2000 to 84 per cent in 2004, suggesting that once employed, it is more likely that full-time and steady employment will follow. This trend was not apparent for those who had not been in work in the 12 months prior to 2000. While the difference between weeks worked in the previous two years by whites and non-whites was not significant in 2000, the gain was less steep for non-whites and the 'gap' became significant by 2004.

The distribution of weeks worked changed dramatically between 2000 and 2004. The distribution was bimodal in 2000; 13 per cent of workers worked every week of the preceding two years. In 2004 the distribution had shifted to nearly 56 per cent of the workforce having worked every week with the rest distributed flatly across the range. Coupled with the increase in overall unemployment of this population in 2004, it appears that the labour force had bifurcated into fully-employed and marginally-employed groups.

Table 2.3: Employment trends in LSAL

Item	n	Mean scores and % 2000	Mean scores and % 2004	% change
Worked in previous 12 months	173	76%	72%	-5
Ratio of weeks (RW) worked in 24 months prior to interview if worked at all in 2000 and 2004	112	74%	84%	13*
Occupational status (prestige score)	83	27	28	4

*Statistical significance, $p < .10$.

The proportion of time worked can be interpreted as employment resilience. This is particularly true in the Portland context where the local recession polarised this particular labour market into two groups, one with more full-time work and the other with little work. There was no difference in the occupational status score over the four-year period.

London

In London 79 per cent of the sample had worked (full-time or part-time) at some point in the 12 months prior to interview in 2000 and 2004 (Table 2.4). Significantly more men than women had been in paid employment (full-time or part-time) in both 12-month periods: 90 per cent to 69 per cent in 2000, 92 per cent to 68 per cent in 2004. Differences between men and women were more marked for full-time employment, with the percentage of women spending any time in full-time work in the 12 months prior to interview dropping from 39 per cent in 2000 and to 33 per cent in 2004 compared with over 90 per cent of men at both time points.

The median number of weeks spent in employment in the *two years* prior to interview in both 2000 and 2004 was 78 out of a possible 104 (75 per cent). Among those who had *ever* been employed during each two-year period prior to interview, the proportion of weeks worked was 86 per cent in both 2000 and 2004.

Considering the figures for men and women separately, the number of weeks worked in the two years prior to interview in 2000 and 2004 remained stable. For men, the proportion of weeks worked in 2000 was 89 per cent and 90 per cent in 2004; for women, the mean number of weeks worked was 63 per cent in both periods. Differences between men and women remained significant even when restricted to those who had ever worked over the period. In 2000 the mean number of weeks worked among those who had ever worked was higher in both years, at 94 per cent for men and 77 per cent for women.

For those in work at time of interview in 2000 and 2004, on a scale of 1–9, the mean occupation score increased significantly from 4.75 in 2000 to 5.06 in 2004. The mean change in occupation score was not significant for men (4.64 in 2000, 4.84 in 2004) but it was for women (4.91 in 2000, 5.34 in 2004). Differences in occupation group were significant between men and women in 2000 but not in 2004.

Table 2.4: Employment trends in BCS70

Item	N	Mean values and % 2000	Mean values and % 2004	% change
Ever worked in 12 months prior to interview	402	79%	79%	0
% weeks worked in 24 months prior to interview (mean)	402	75%	75%	0
% weeks worked in 24 months prior to interview (if worked at all in 2000 or 2004) (mean)	350	86%	86%	0
Occupational status (if working in 2000 and 2004)**	254	4.75	5.06	6*

*Statistical significance, p<.10. **Occupational status as measured by SOC90. There are nine occupation groups. Lowest status jobs are coded '1', highest status jobs are coded '9'.

Portland and London: Employment compared

The bar graphs in Figure 2.4 show how some employment conditions differed between the two countries. The London sample appeared to enjoy fuller and more sustained employment in 2000 and 2004 compared to the Portland urban area. Although 21 per cent of the London sample were not engaged in paid employment at both time points, this increased in Portland from 24 per cent to 28 per cent between 2000 and 2004. In addition, a much higher proportion of the sample in London worked consistently every week at both time points; 67 per cent compared to just 10 per cent of the Portland sample in 2000. In London in 2004 69 per cent worked every week and in the Portland area workers experienced a threefold increase in full employment during this time, increasing from 10 per cent to 38 per cent.

As Figure 2.3 showed, the increase in full employment in Portland was coupled with a 90 per cent increase in the proportion of those in jobs using computers, outpacing the 14 per cent increase in London. In 2000, 42 per cent of London workers in the study population used a computer in their job compared with 30 per cent of Portland workers. The differential rate of change left 57 per cent of respondents in jobs in Portland using computers compared to 48 per cent in London.

Figure 2.4: Comparative BCS70 and LSAL employment trends

Figure 2.4a: LSAL weeks worked in previous 104

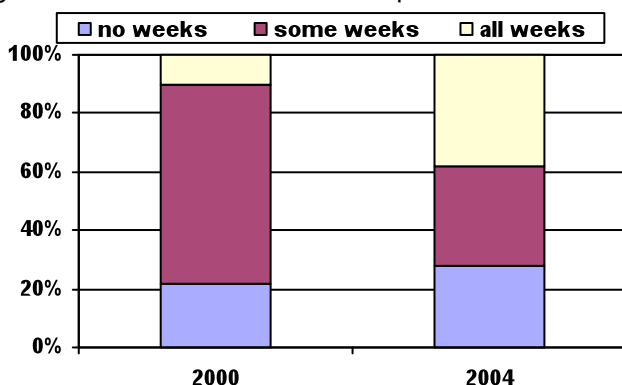
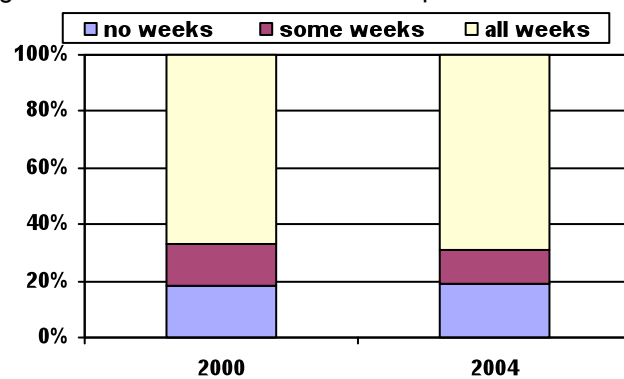

Figure 2.4b: BCS70 weeks worked in previous 104



The three divides in summary

We have seen from the data that literacy proficiency is stable over this short time frame. However, computer ownership and use at home, while relatively stable in Portland, increased dramatically in London during the four-year period, reaching parity in 2004. Conversely, computer use in the work environment increased dramatically in Portland but not in London. Although a similar proportion of respondents in Portland and London had spent some time in employment, the more buoyant economic conditions in Britain at this time meant far more men and women experienced consistent employment.

In the next chapters we use structural equation modelling (SEM) (Kline1998) to explore the interrelationships among literacy proficiency, computer use and employment over the four-year period of 2000–2004 in the different contexts of Portland (USA) and London and the London (UK).

3. Modelling the relationships among the divides across time

In the previous chapter we saw that although literacy proficiency measured in Portland did not vary on average across the four years, there was a change in ICT take-up and also the pattern of ICT take-up at home differed between Portland and London. Portland's levelled off after earlier take-up, whereas in London it increased over the whole four-year period. Contrasting economic conditions resulted in a stagnant or contracting labour market in Portland, while in London the labour market was expanding. There was evidence too that employment in the jobs market in Portland was associated with ICT competence, whereas this effect was less evident in the London labour market.

In this chapter we move to the next step of modelling the changes in the three domains of literacy proficiency, ICT use and employment to determine how changes in the three domains are related to each other. To do this we use structural equation modelling (SEM). This involves estimating the strength of the relationships among the three divide variables at each time point and between the two time points. We also include a number of 'control' variables with which these relationships might be confounded to see, for example, how strong the relationship between ICT use and literacy proficiency is when gender, ethnicity (US only) and parents' education, etc, are taken into account.

One of the main benefits of using structural equation modelling here is that it offers a possible explanation of the relationships among the divide variables between the two time points. We first run a 'fully saturated' model, whereby all divide variables are considered to influence each other across time. Based on the results of this model, we can then see which, if any, of the relationships between the divide measures to 'constrain', providing there are good theoretical grounds, to zero. For example, if the unconstrained model showed that there was no relationship between ICT use in 2000 (Time 1) and time in employment in 2004 (Time 2) then this relationship (pathway) would be 'constrained' to zero. Compared to the fully saturated model, the constrained model allows an estimate of how well the model fits the data.

Generic Model

Figure 3.1 shows the generic form of the model that we evaluated. The boxes on the left show the measures of the three divide variables in 2000, Time 1: Literacy proficiency (LP), ICT use (ICT) and Employment (EMP). The boxes on the right show the 2004, Time 2, measures of the same variables. The main focus of interest in the model are the straight lines, described as 'paths' which show the relationships among the two sets of variables across time (2000 to 2004).

The paths that link the repeated measures of the same variable across time, e.g. ICT use between 2000 (Time 1) and 2004 (Time 2) (a), indicate the extent to which sample members were changing over time with respect to this measure, i.e., its *stability*. The diagonal paths crossing from one variable to another across

time (“cross-lagged” relationships’), indicate the direction of influence (b). If the estimated coefficient for a pair of variables is stronger for one cross-lagged path than the other, we can infer that the former is reflecting the stronger influence or effect. For example, if the path from literacy proficiency in 2000 (Time 1) to ICT use in 2004 (Time 2) is stronger than the path from ICT use in 2000 (Time 1) to literacy proficiency in 2004 (Time 2) then we can infer that literacy proficiency has a stronger influence on ICT than ICT has on literacy proficiency. The curved lines (c) connecting the variables represent the correlations between the divide variables at each time point (2000 or 2004).

In addition to the core divide measures in the structural equation model, various control variables are included, e.g. gender, ethnicity (US only), etc. The model estimates for these variables are shown, together with all the other model estimates, in Appendix 2.

In 2000 (Time 1), the variables are assumed to be ‘exogenous’ or ‘fixed’, i.e. unaffected by any changes in the (‘endogenous’) variables to the right of them in the model and the correlations between them are the same as in the raw data on which the modelling is based. The correlations in 2004 (Time 2) are estimates derived from the model itself. The strengths of all the other paths in the model (cross-lagged or controls) are estimated as partial regression coefficients. For convenience of interpretation these path coefficients are usually standardised to have the same range as a correlation coefficient: -1 to +1.

Figure 3.1 Two time-point, three variable cross-lagged structural equation model

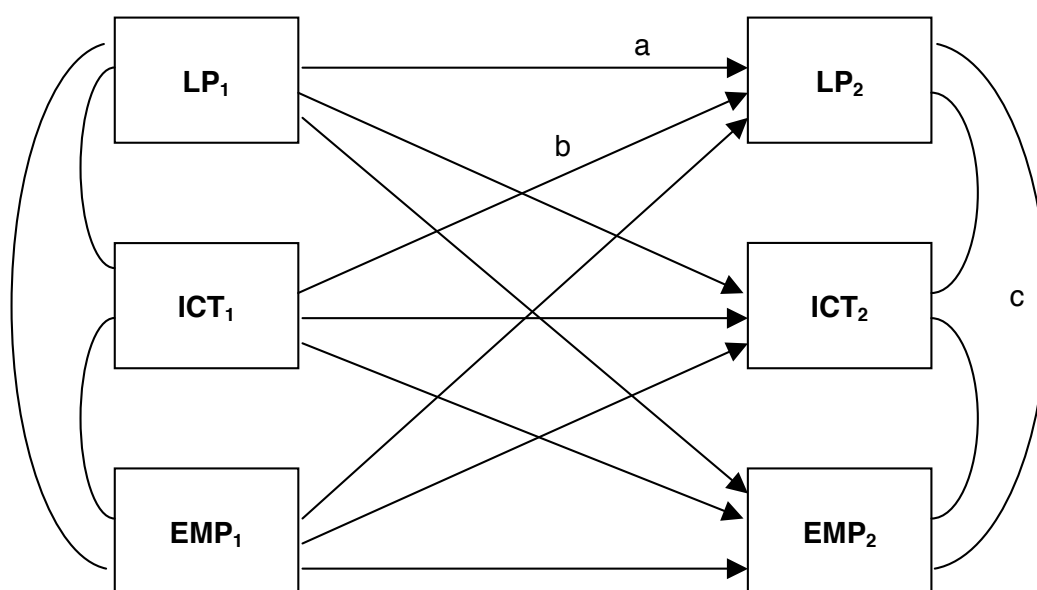

Note: LP = Literacy proficiency, ICT = Computer use, EMP = time in employment.

As noted earlier, two types of model can be evaluated – a ‘fully saturated’ model in which a maximum number of plausible paths in accordance with the temporal sequencing of the variables are estimated, and a ‘constrained’ model in which some of these paths are fixed at 0. In this latter case the fit of the model is then tested against the observed data and evaluated using a number of goodness of fit indices that help to determine how well the covariance structure among variables implied by the model is reproduced in the observed data. The model-

estimated coefficients themselves can be appraised for statistical significance, i.e., whether a non-zero path strength estimate is unlikely to have occurred by chance at a given probability level.

Because of the relatively small samples involved, especially in the Portland study, a probability of $p < .10$ was again used as the significance criterion. This says that for the given sample size the probability of the estimate being a chance result i.e. not significantly different from zero, is less than 1 in 10. However because the p values on which statistical significance is judged are functions of sample size and the samples differ substantially between Portland and London, caution is needed, especially when judging the statistical significance of estimates that are being compared between the two localities.

Strategy for evaluating the model

Initially we sought a single model that could be operationalised in both datasets. However, the Portland study was designed to track literacy over time and therefore had a repeated measure of literacy proficiency. As noted in the previous section, the London study literacy proficiency was measured in both the 2000 and 2004 BCS70 survey only as a self-report of basic skills problems (reading or writing). But the numbers reporting difficulties – 12 per cent at 2000 and 8 per cent at 2004 – were too small for effective structural equation modelling. In 2004 the 30-item literacy proficiency measure in BCS70 had some similarities in terms of literacy content covered by the TALS measure used in Portland. Accordingly we developed our analytic strategy in three stages.

1. **Portland Model** – This comprised evaluating the model shown in Figure 3.1 using the LSAL data, with literacy proficiency at both time points (LP_1 and LP_2)
2. **Comparative Model** – The next step was to evaluate a modified model (benchmarked against the Portland Model) in both Portland and London, with literacy proficiency included only at Time 2 (LP_2). Since there is no Time 1 measure for literacy proficiency (LP) in this model, LP_1 cannot be ‘conditioned’ out of the estimated relationships between variables as in Model 1. However replication in Model 2 of the overall patterns in model across the two studies can be taken as support in London for the Portland Model 1 findings.
3. **Elaborated London Model** – The larger sample size in London enabled testing of further variations in the model. First we tested the comparative model separately for men and women to demonstrate the different ways in which the three divides operated between them. The second elaboration was to replace the time spent in employment divide variable with occupational status (SOC) in the model. This was measured at Time 1 and Time 2 and could be used to tease out the possible effect of changes in occupational status on the other variables. Is there a premium attached to ICT and literacy proficiency in career progression as measured by occupational status?

The same control variables were included in all three forms of the model: gender, ethnicity¹⁷ (US only), parents’ education and number of dependent children.

¹⁷ Ethnicity i.e. being white and a native speaker of English, or not, is an important construct in the US context but was not available in the BCS70 data. Parents’ education is a proxy for class status and opportunity structures in both the US and the UK.

Full details of the results for all models are given in Appendix 2.

Portland Model

In preliminary analyses, the two measures of employment discussed in Chapter 2 were tested in separate models: occupational status as measured by the prestige score (SOC) and proportion of weeks employed in the previous two years (EMP). The model using occupational prestige showed no significant cross-lagged effects so this measure was discarded in subsequent model testing. Having settled on a measure of employment, we evaluated two versions of the Portland Model using different measures of ICT use: computer use in the work context (Model A) and computer use at home or at work (Model B). Both models were tested in fully saturated and constrained forms in which paths close to zero were fixed at zero; the two models were contrasted for goodness of fit.

Both version A and version B of the Portland Model showed the same general pattern of relationships among variables with some variation for one of the divide variables. Version A showed the stronger relationships and these are shown in Figure 3.2. (Table A1a in Appendix 2 shows the estimates for Model A and Model B. Table A1b compares the saturated and constrained estimates for Model A). From this point forward, computer use in a work context became the focus of our analyses. To aid interpretation all the model estimates as obtained for the saturated version of the models are shown in the diagrams that follow, with statistical significance indicated by the weight of the lines in each diagram.

It is immediately apparent that the main direction of influence in Model 1 is from employment and ICT at Time 1 to literacy proficiency at Time 2, rather than literacy proficiency at Time 1 influencing ICT and employment at Time 2. Employment shows the larger influence (path coefficients are .21 and .15, respectively). It is notable that there is also a modest path from ICT at Time 1 to employment at Time 2 (.14). In other words, ICT improvement appears likely to boost both literacy proficiency and the likelihood of being employed. (This relationship is actually stronger for ICT used at home or work than for ICT used only at work.)

Figure 3.2 Portland Model (A)

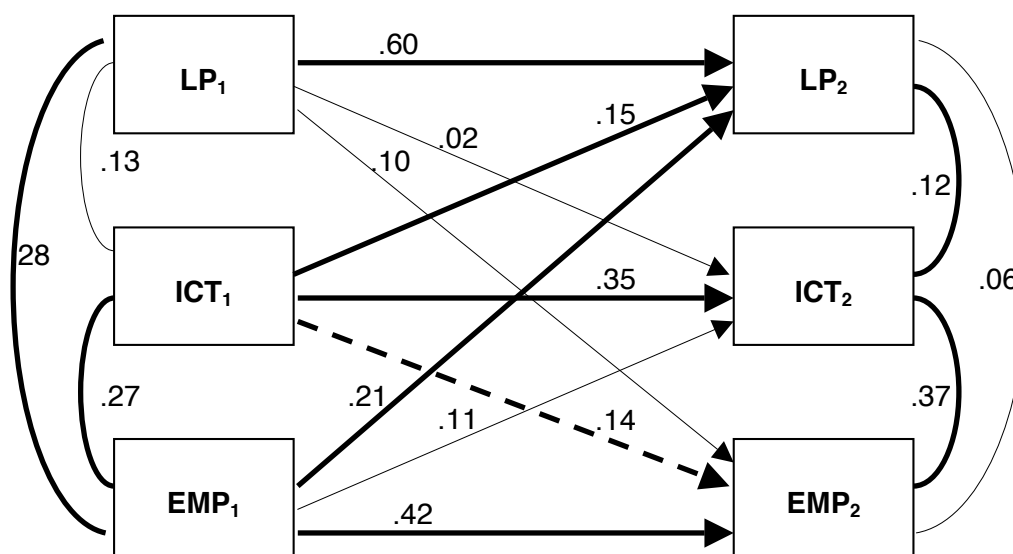

Note: LP = Literacy proficiency, ICT = Computer use, EMP = Time in employment. Bold lines indicate standardised path coefficients significant at $p < .10$. Dashed lines indicate close to significance, i.e. $p > \text{or} = .10$. Other lines indicate not statistically significant.

Another notable feature of the model is the relatively weak correlation at Time 2 between ICT and literacy proficiency (.12), contrasted with the relatively strong correlation shown between employment and ICT (.37) at Time 2 than at Time 1 (.27). Notably too, parents' education shows statistically significant paths to literacy proficiency, to ICT and to employment, identifying pervasive social class effects (Table A1a, Appendix 2). Race, gender and the number of dependent children also exhibit significant relationships with the divide variables, particularly at Time 2.

As a final test of the model, the statistically insignificant paths in Figure 3.2 were *constrained*, by fixing them at zero. The goodness of fit of the model to the observed data was then re-assessed. The fit of the model was good reflecting a close correspondence between the covariance matrix implied by the model and the observed covariance matrix. We therefore conclude that Model 1 is a good representation of the relationships among the variables involved. The full set of estimates is provided in Table A1a in Appendix 2.

Comparative Model

The parameter values (correlation coefficients and path coefficients) estimated for Model 1 in Portland reflect the pattern of possible influences among the three divide variables across the two time points. We now examine the extent to which the pattern is sustained in the modified model (Model 2) tested in both Portland and in London, in which Time 1 literacy proficiency (LP₁) was removed. Our aim here was to determine to what extent different patterns of take-up of ICT and employment in Portland and London, reflected by the differing labour market conditions in the two locations, differentially impacted on the model's path coefficients and consequently the pattern of influences among the three divide variables.

First, if the strength of a path between the original and comparative versions of the Portland Model is sustained, then it suggests that the initial literacy levels achieved by individuals by Time 1 had no substantive effect on the pattern of influence. This gives confidence to the interpretation of the direction of influence between the three divides.

Secondly, if a given path coefficient is similar for both Portland and London, then the direction of its influence is unaffected by the contextual features of the two locations. On the other hand, if there is a difference in a given path coefficient between Portland and London, then the explanation should be sought in the contextual differences. For example, the relatively stagnant or contracting labour market in Portland over the four-year period compared with the buoyant and expanding labour market in London, might account for the different relationships among the relevant variables. Other contextual features to consider of course are the different education systems and policy frameworks operating in the two countries, though none of our findings pointed strongly in this direction.

Comparative Model: Portland

Figure 3.3a shows that, although the majority of the values of the path coefficients were maintained between the original and comparative Portland Models, there was one substantial change. The path representing the influence of employment at Time 1 on literacy proficiency at Time 2 doubled in strength in the comparative model (from .21 to .43), which suggests that the influence in the comparative model now embraces literacy proficiency at Time 1 as well, i.e. the effect of literacy proficiency is included in the effect of employment on literacy proficiency at Time 2. Notably, there was no effect of this kind apparent between ICT at Time 1 and literacy proficiency at Time 2. The coefficient remained virtually unchanged (.15 compared with .17). The origins of the difference can be seen in the correlations between the variables at Time 1 in the original Portland model (Figure 3.2). There was only a relatively weak correlation between literacy proficiency at Time 1 and ICT (.13) at Time 1. This compared with more substantial correlations between employment at Time 1 and literacy proficiency at Time 1 (.28) and ICT at Time 1 and employment at Time 1 (.27). A constrained version of the model was also evaluated and a good fit to the data obtained. Again, setting non-significant coefficients to zero made no difference to the pattern of relationships previously estimated.

Figure 3.3a Comparative Model – Portland (ICT at work)

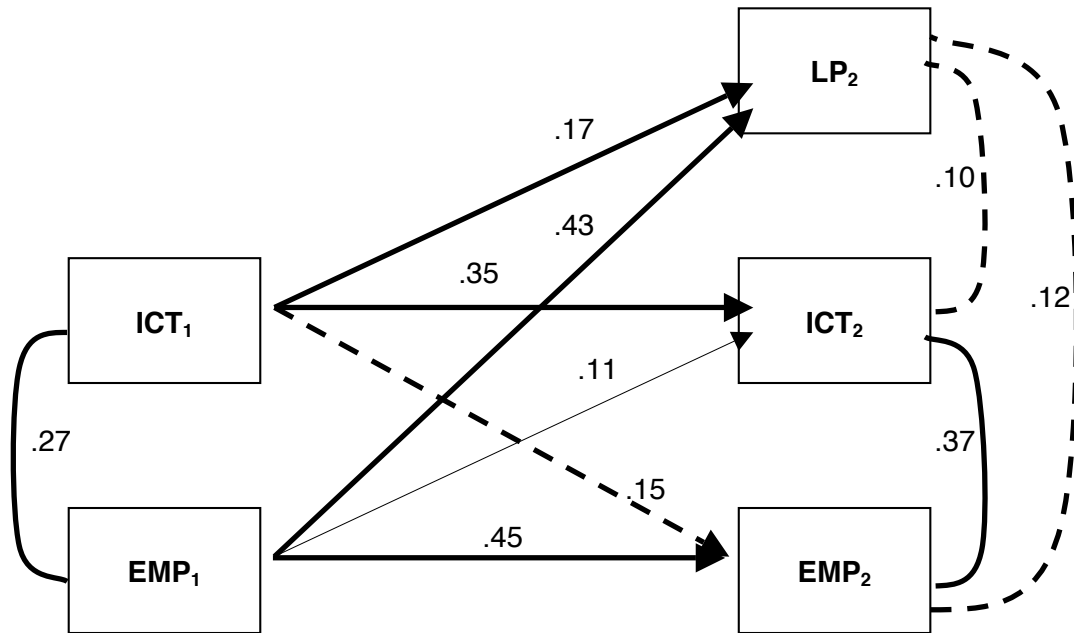

Note: LP = Literacy proficiency, ICT = Computer use, EMP = Time in employment. Bold lines indicate standardised path coefficients significant at $p < .10$. Dashed lines indicate close to significance, i.e. $p > .10$. Other lines indicate not statistically significant.

Comparative Model: London

Figure 3.3b shows the path coefficients and correlation coefficients for the comparative model using the London data. There were some differences and some similarities with Portland, notably in relation to the cross-national stability of relationships of the ICT and employment variables (as assessed from the path coefficient for the same variable measured across the two time points). Stability of employment between Time 1 and Time 2 appeared to be somewhat higher in London (.55) compared with Portland (.45), reflecting the more volatile labour market in Portland. ICT use at work was also more stable over time in London (.56) than in Portland (.35), this time reflecting the huge growth in ICT use in the workplace in Portland during the period covered. In London there was relatively little growth in ICT use at work for this section of the population. Thus earlier use of ICT is a stronger predictor of later ICT use in London than in Portland.

Figure 3.3b: Comparative Model – London (ICT at work)

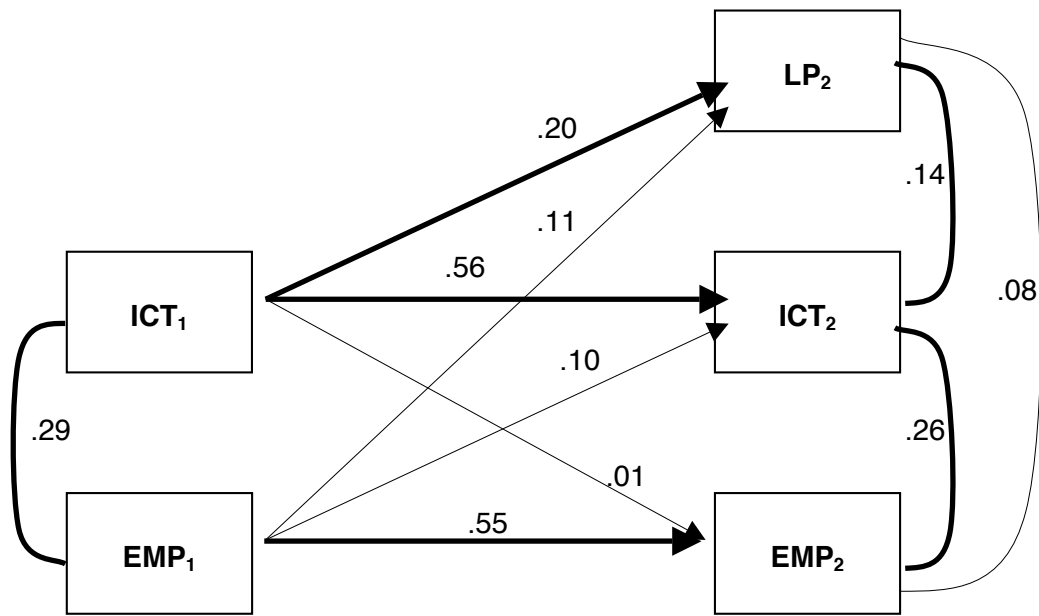

Note: LP = Literacy proficiency, ICT = Computer use, EMP = Time in employment. Bold lines indicate standardised path coefficients significant at $p < .10$. Dashed lines indicate close to significance, i.e. $p > \text{or} = .10$. Other lines indicate not statistically significant.

Other notable differences are in the cross-lagged paths reflecting influences between the divide variables over time. Although the path coefficients from ICT use at Time 1 to literacy proficiency at Time 2 are similar (.17 in Portland and .20 in London), the paths from employment at Time 1 to literacy proficiency at Time 2 are substantially different in the two settings (.43 in Portland and .11 in London). This suggests that being in employment is much more closely tied to literacy proficiency in Portland than it is in London.

Correlations between the variables at Time 2 are quite comparable between the two locations. The largest difference is between ICT and employment, where the relationship is stronger in Portland (.37) than in London (.26).

The relationships between the divide variables and the control variables are also different in the two contexts. They are generally weaker in Portland, with the exception that the number of dependent children is positively related to employment at Time 2 (.25). In London, being female is positively related to literacy proficiency at Time 2 and (unsurprisingly) negatively related to employment at Time 2. Full details of these results are provided in Table A1a and A2 in Appendix 2.

Conclusions: Portland and London Models reviewed

The relationship between computer use in 2000 and literacy proficiency in 2004 was replicated in the two locations. There was however a substantial difference with respect to the apparent influence of employment on literacy proficiency. Employment appears to be exercising a much stronger influence in Portland on literacy proficiency than in London; though in both locations a statistically significant relationship between these two divide variables is evident with

stronger effect for women than for men. In London, a significant relationship was also evident between employment in 2000 and computer use in 2004, whereas no such influence was in evidence in Portland.

During this four-year period, employment was much more consistent and at a higher overall level in London than in Portland, suggesting that in Portland employment may have been an important factor in raising literacy proficiency levels. The potential role of ICT in increasing the probability of employment is also clearer in Portland than in London (.37 compared with .26), suggesting that in a relatively unstable and even contracting labour market, people seeking work who possess ICT skills are more likely to gain employment. The buoyancy and high level of activity in the London labour market may indicate that ICT is less of a factor in employment. However, we might expect that as the labour market contracts (as in the present economic climate), ICT will become a bigger factor in employability in London as in Portland.

4. Elaborated London Model

The previous chapter showed how the model developed and tested for the Portland data, as reflected in the pattern of influences among the three divide variables across the two time points, was broadly replicated using the comparative form of the model. However, although the part of the model concerned with the relationship between ICT and literacy proficiency was replicated in London, some of the other key relationships varied.

The next step in the analysis was to elaborate the London model, taking advantage of the larger sample size available. Two extensions were evaluated: the first tested the comparative model separately for men and women. The second replaced Time in Employment (EMP) with Occupational Status (SOC), which was also measured in both 2000 and 2004. As for the earlier versions of the model, control variables were included – social background as measured by parental education, gender and the number of children the cohort member had by the age of 30 in 2000 (Time 1).

Elaborated London Model: men and women compared

In Figures 4.1a and 4.1b we see the result of estimating the models separately for men and women. Although a significant relationship between ICT use in 2000 (Time 1) and literacy proficiency in 2004 (Time 2) was found for both men and women (.18 and .19 respectively), there were notable differences in other features of the models for men and women

Figure 4.1a shows that for men the strongest cross-lagged paths are from ICT use and amount of employment experienced in 2000 (Time 1) to literacy proficiency at Time 2 (.17 and .18 respectively). All the other cross-lagged paths are much weaker. However, the stabilities of the divide variables are stronger for men than for women (.72 and .41 for ICT, .66 and .52 for time in employment).

Figure 4.1b shows that for women an additional influence is apparent between employment in 2000 (Time 1) and ICT use in 2004 (.18). However, time in employment in 2000 does not appear to influence literacy proficiency at Time 2 (.08) as it did for men. These results also suggest that for women, employment has more bearing on the development of their ICT skills than it does for men. For men, who were much more likely to be in manual jobs, time spent in employment has little bearing on their use of ICT in the work environment. Where there was use of ICT, this would signify relative improvement in their employment position. For women, the much stronger correlations between ICT use and time spent in employment at both Time 1 and Time 2 point to the significance of employment in skills development.

There was no apparent impact of social background or having children on any of the measures in the model for women, but for men, a higher status social background as reflected in parents' education is positively related to both time spent in employment and literacy proficiency. Full details of these results are provided in Table A2 in Appendix 2.

Figure 4.1a Elaborated London Model: men

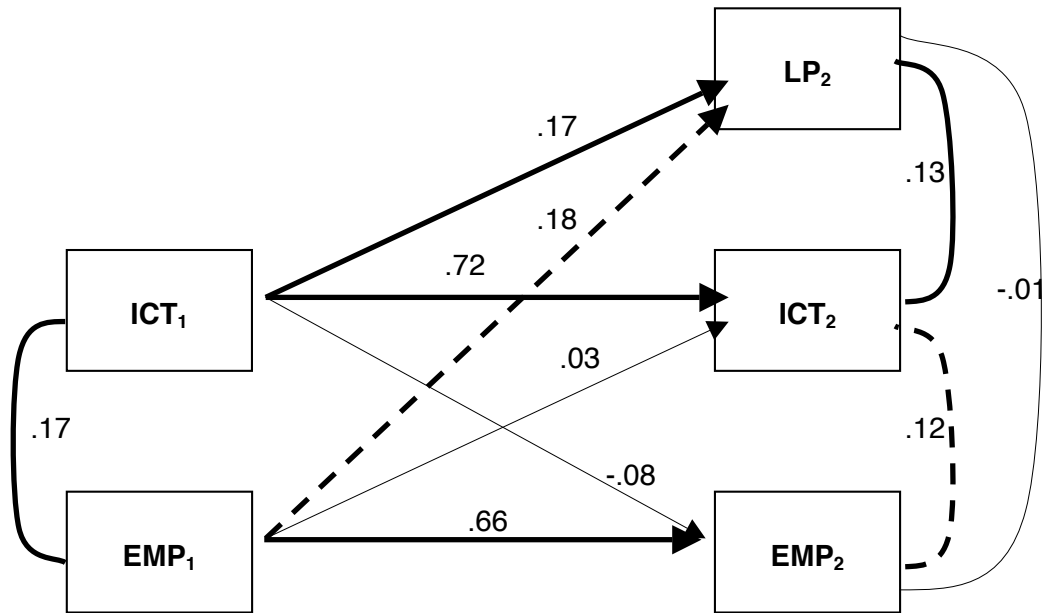
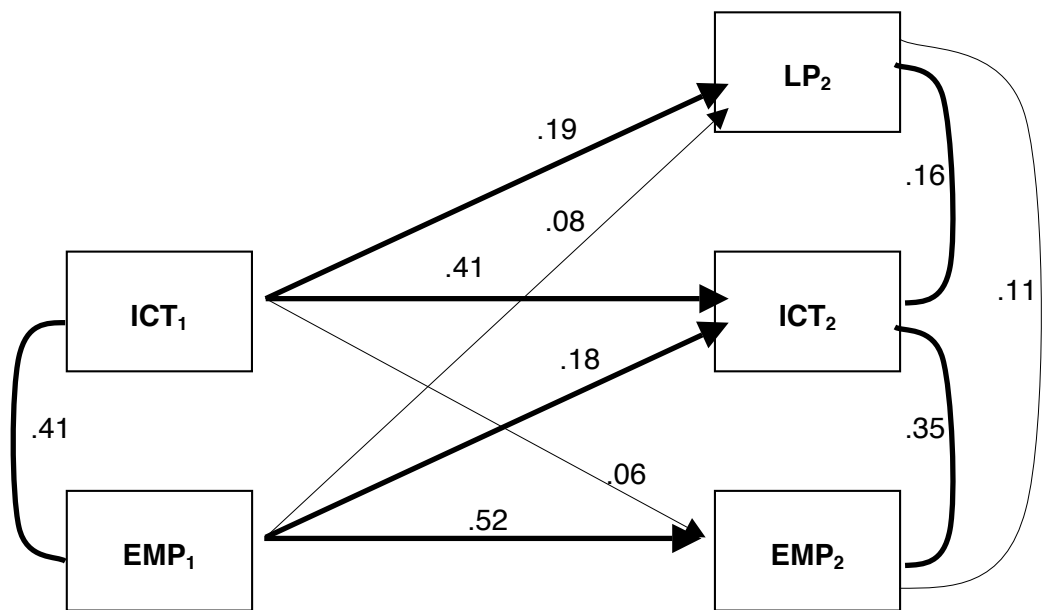

Figure 4.1b Elaborated London Model: women



Note: LP = Literacy proficiency, ICT = Computer use, EMP = Time in employment. Bold lines indicate standardised path coefficients significant at $p < .10$. Dashed lines indicate close to significance, i.e. $p > \text{or} = .10$. Other lines indicate not statistically significant.

Conclusion

These results show the value of estimating the models separately for men and women. Although ICT use in 2000 appears to have an influence on literacy proficiency in 2004 for both men and women, the other relationships in the Elaborated Model notably differed.

For men, the other significant relationship is between amount of employment experienced in 2000 and literacy proficiency in 2004, whereas for women the other strong relationship is between employment in 2000 and ICT use in 2004.

Employment appears to provide a means of access to ICT for women, which in turn over time could then raise literacy proficiency. For men, employment appears to have a direct influence on literacy proficiency.

These results also suggest that for women, employment has more bearing on the development of their ICT skills than it does for men. For men, who were much more likely to be in manual jobs, time spent in employment has little bearing on their use of ICT in the work environment. Where there was use of ICT, this would signify relative improvement in their employment position. For women, the stronger correlations between ICT use and time spent in employment at both Time 1 and Time 2 point to the significance of employment in skills development.

Elaborated London Model: including occupational status

Occupational status is based on the occupation held at the time of interviews in 2000 and 2004. Missing data for respondents not in employment, including occupational status, had the effect of reducing overall sample size, especially for women (i.e. sample size was reduced from 356 to 232). We first evaluate the model for both sexes combined and then examine it for men and women separately.

As might be expected, Figure 4.2 shows that occupational status in 2000 (Time 1) is positively related to literacy proficiency (.13) and ICT use (.21) in 2004 (Time 2): scores are higher for both divide variables the higher the starting occupational status at Time 1. Occupational status at Time 1 is also strongly related to occupational status at Time 2 (.55) indicating relatively little individual movement across the four-year time period.

Figure 4.2: Elaborated London Model: including occupation status

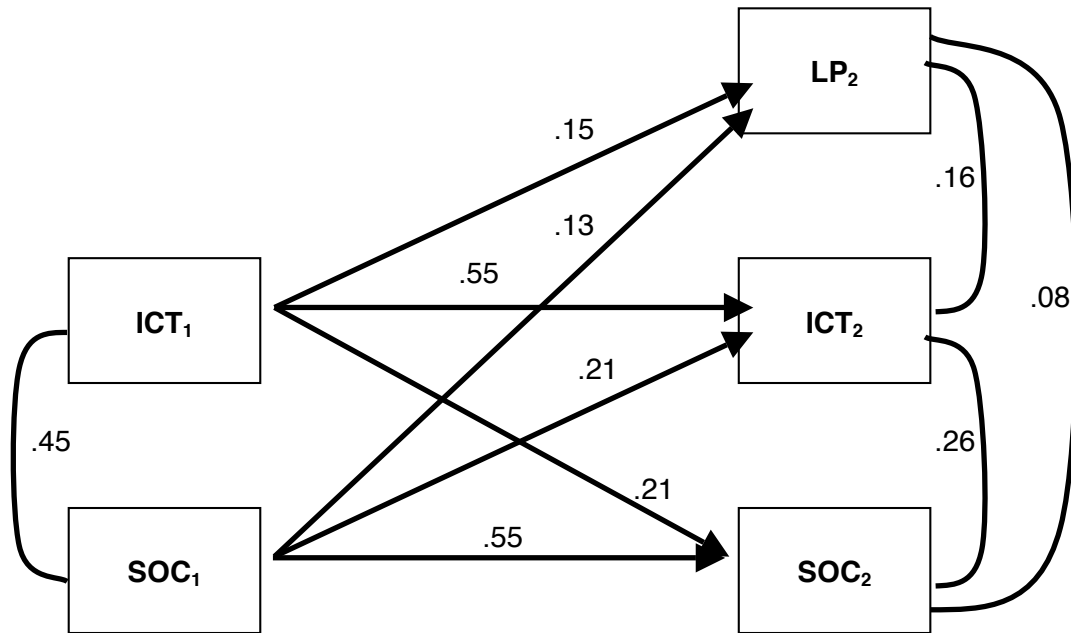

Note: LP = Literacy proficiency, ICT = Computer use, SOC = occupational status. Bold lines indicate standardised path coefficients significant at $p < .10$. Dashed lines indicate close to significance, i.e. $p > \text{or} = .10$. Other lines indicate not statistically significant.

ICT use in 2000 (Time 1) is significantly related to occupational status in 2004 (.21), whereas it had not been related to time spent in employment previously. ICT use in 2000 (Time 1) is again significantly related to literacy proficiency at Time 2 (.15).

Turning to the correlations between the three divide variables in 2004 (Time 2), literacy and ICT use remain positively correlated (.16), and now both literacy and ICT are significantly correlated with occupational status (.08 and .26 respectively). The control variables show similarly changed relationships. Without occupational status in the model (Table A2, Appendix 2), being female is positively related to literacy proficiency and negatively related to proportion of time in employment at Time 2. With occupational status in the model (Table A3, Appendix 2), being female and having fewer children are related to ICT use at work at Time 2. Parental education now also shows a positive relationship with literacy proficiency (Table A3, Appendix 2).

Elaborated London Model: including occupational status and gender

This model was also evaluated separately for men and women. Similarities and differences in the relationships among the three divides are again apparent.

In Figures 4.3a and 4.3b, we see that for both men and women ICT use in 2000 (Time 1) continues to be related to literacy proficiency (.14 and .18 respectively) and occupational status in 2004 (Time 2) though more strongly for men (.26 and .16 respectively). Under the reduced sample size, statistical significance is not

reached between ICT use and occupation status for women (n = 95). Occupation status in 2000 (Time 1) similarly relates to literacy proficiency in 2004 (Time 2) for men and women (.15 and .16 respectively). It is also significantly related to ICT use at work in 2004 (Time 2), though the size of the estimate is larger for women (.16 men, .30 women). These results perhaps give the strongest evidence that, at least in London, ICT access and use support progression in employment for men. This is less the case for women where having a high status job appears, more than for men, to increase the likelihood of using ICT at work.

Figure 4.3a: Elaborated London Model: occupation status for men

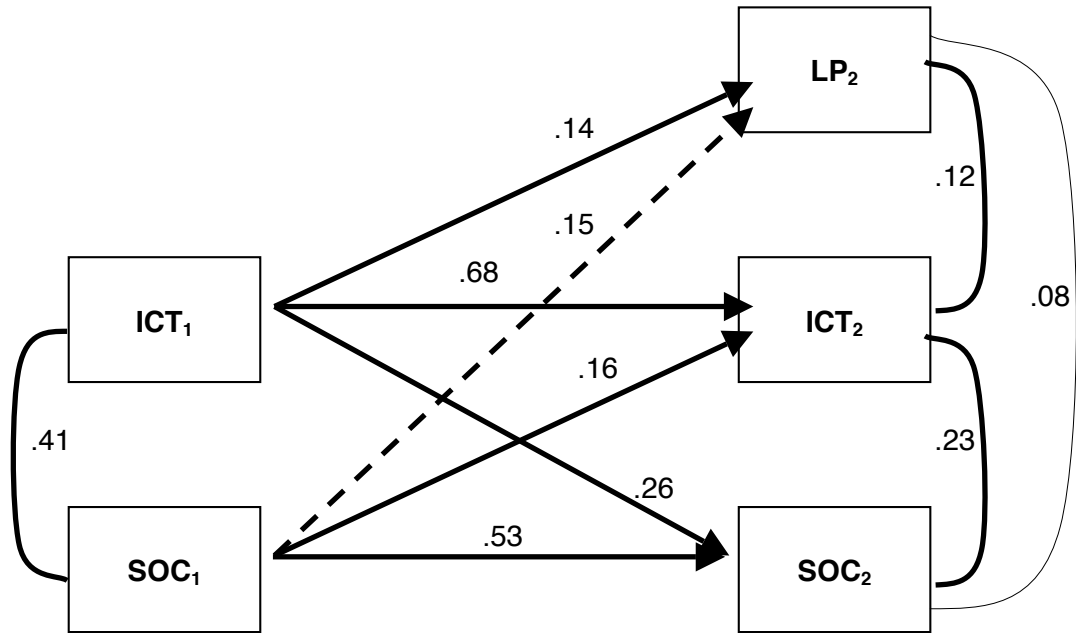

Note: LP = Literacy proficiency, ICT = Computer use, SOC = occupational status. Bold lines indicate standardised path coefficients significant at $p < .10$. Dashed lines indicate close to significance, i.e. $p > \text{or} = .10$. Other lines indicate not statistically significant.

Figure 4.3b: Elaborated London Model: occupation status for women

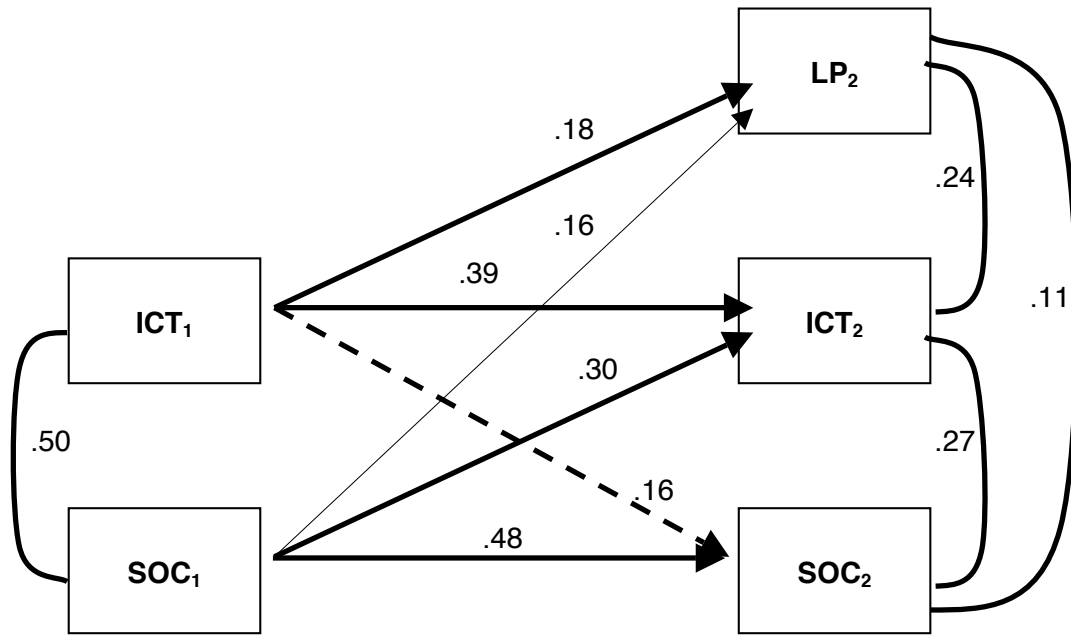

Note: LP = Literacy proficiency, ICT = Computer use, SOC = occupational status. Bold lines indicate standardised path coefficients significant at $p < .10$. Dashed lines indicate close to significance, i.e. $p > \text{or} = .10$. Other lines indicate not statistically significant.

Conclusions

The final Elaborated Model shows that within this low education London sample, the relationships of ICT use within employment across time are different for men and women. In the case of men, computer use appears to lead to higher status occupations, which then leads to improved literacy proficiency. For women, many of whom have spent time out of the labour market during this four-year period to take up childcare responsibilities, the time spent in employment is also key to the type of occupation they hold and thus their ICT use at work. ICT use thus provides the means of raising literacy proficiency levels. Full details of these results are provided in Table A3 in Appendix 2.

5. Conclusions

We started this report by considering the changing significance of ICT competence and literacy proficiency for employability in the contemporary economy. Only 30 years ago poor literacy was no impediment to getting a job and digital competence had yet to impact on the nature of employment in any significant way. Today, fuelled by the emergence of computers in every area of work, those without ICT skills – on the ‘wrong side’ of the digital divide – are likely to have their opportunities for getting work curtailed; they are also likely to find their opportunities for progress in their job impeded.

The transformation of employment through the ICT revolution and the growth of vast new industries driven by it in what becomes increasingly a global economy contributes to the third of our divides: the employment divide and associated status of the job a potential employee is able to get. Another significant feature of the contemporary labour market is thus *polarisation* identified with the widening gap between those who have the skills demanded by employers and those who lack them. There is increasing emphasis in job recruitment on evidence of educational achievement as certified through qualifications for which literacy proficiency and now ICT competence supply the foundations. Those without these skills face an employment career characterised by casual work interspersed with periods of unemployment. When the local economy contracts those without these skills are likely to be the first to lose their jobs and when it expands the last to gain new ones.

But the relationships involved among the three divides are not straightforward. A key moderator is the special features of each education system including the parts concerned with the education of adults. The finding from OECD’s IALS that the prevalence of poor literacy was three times higher in the US and Great Britain than in Sweden suggested that some education systems were more effective in imparting the basic skills to their populations than others (OECD 1997). Another factor in the development and operation of the three divides is the special features of the local labour market. These determine whether jobs are available at all and if so, what kinds of job they are.

The study reported here attempted to gain some insights into these processes through a comparative longitudinal study. The existence of comparable longitudinal data collected from adults in Portland, Oregon and London, England for the same age groups over the same four-year period made the case for constructing matched datasets containing broadly comparable variables. These datasets were used to operationalise the three divides in both countries. They were then analysed by structural equation models to establish both the strength of relationships among the key variables across time and, most importantly, their direction. Is enhanced literacy proficiency a driver of employability and enhanced IT competence or is the main flow of influence from these latter variables in the opposite direction i.e. as enhancing the prospects of employment?

The work involved in matching what was, in some respects quite disparate data, was more challenging than first envisaged, not least because of sample and measurement differences between the two studies that could only be resolved

through making very strong and perhaps not always fully sustainable assumptions. Nevertheless the findings from the modelling with interpretation of similarities and differences between the Portland and London models, aided by the descriptive data about their local economies and labour market, add up to a convincing narrative of how the processes of labour market inclusion and exclusion are manifested through the three divides. The narrative is, of course, conditional on when and where the studies that produced the models took place.

First, the different economic conditions in Portland and London across the period studied contrasted a relatively stagnant labour market for most of the four-year period in Portland with a buoyant labour market for the whole period in London. In Portland, this placed a higher premium on ICT use at home or in the workplace for building the competence needed to obtain and progress in employment. This contrasted with London, where, for men, ICT competence was more strongly related to progressing to higher status jobs from a base of employment than to finding a job. For women digital skills could be useful in getting a job, but were mainly important for raising literacy proficiency especially from the base of a high status job.

Portland was initially ahead of London in take-up of ICT, but by the end of the four-year period, the difference in ownership and use of computers and the internet had largely disappeared. However, a larger percentage of the study sample used a computer at work at the end of the period in Portland than in London, reflecting the larger amount of IT-based employment in the former locality. Notably, however, a solid minority of up to one in five in both locations still had little access to, or use, of ICT. For them the digital divide appeared to be still very much in place.

Literacy proficiency, a key factor in employability, appeared to benefit more from improvement in the other divide variables of ICT use and time in employment, together with improved local labour market conditions, than influencing these other variables directly itself.

For men in London, ICT use was also associated with progression in employment, whereas for women it was more closely aligned with being in employment possibly after a period out of it.

We can bring these findings together through vignettes that identify the way the different divides were operating in the two settings. In a stagnant or contracting labour market, where unemployment is increasing, people with ICT competence are more likely than others without this competence to find a job. This is even more likely when they use the skills at home as well as at work. Moreover, when they are working, they tend to use the ICT skills a lot. Access to employment and ICT use appear to bring the added benefit of enhancing literacy proficiency which is likely to aid progression in the job. The Portland data did not identify strong gender differences with respect to these processes pointing to possible features of the social security systems that discouraged more women in Portland than in London from replacing employment by childcare.

In London the gender differences were marked, pointing to different scenarios for the role of ICT and literacy proficiency and employment for men and women. For men in the buoyant London labour market, continued employment was probably not so much dependent on ICT competence or literacy proficiency as it was in

Portland. Where these skills mattered was in the process of rising up the occupational status ladder, e.g., getting a foreman's job or setting up a business. For women, although ICT competence at work did not predict later employment, ICT skills developed at home or in classes could be a boost to employment prospects. Women in employment were also significantly more likely to be using ICT at work than those who were out of the labour market. It is at this stage that enhanced literacy proficiency can turn a negative cycle into a positive one.

These conclusions stress the positive side of improvements in competence that are likely to strengthen engagement with the labour market – that is to say 'virtuous' circles where enhanced skills work in tandem with employment experience to reinforce prospects further. The 'vicious' side of the circle is also evident from our findings. Lack of ICT access and use coupled with poor literacy is likely to damage employability further. The consequence is more, rather than less, marginalisation in the labour market. It follows that adult education provision needs to be improved and updated continually so that it keeps up with employment demands.

The findings from the structural equation models thus point clearly to the conclusion that boosting literacy proficiency is unlikely to be sufficient to reverse the labour market exclusion process on its own. A combination of provision that raises digital competence and the creation of employment opportunities is needed to ensure that all potential employees have access to literacy and numeracy and the ICT skills that will give them access to modern jobs. For those in employment, skills enhancement has the benefit of supporting career progression, motivating further skills learning and contributing to workplace productivity. At times of economic downturn and redundancy, or periods out of the labour market, e.g. to have children, skills acquisition and updating can be centrally important in helping potential employees return to work.

This endorses current UK government initiatives such as Train to Gain, the aim of which is to support employers who wish to enhance the skills of their work force. The benefits of having a skilled work force are likely to be reflected in greater flexibility, adaptability, productivity and greater profitability.

The spread of ICT use reflects the widespread take-up of digital technology. However, there remains in most communities a concentration of individuals and families who, for whatever reason, make little use of, or are effectively excluded, from the internet and ICT more generally. Added to what are often poor literacy and numeracy skills their disadvantages in the labour market are compounded. This underlines the importance of adult continuing education provision to supply the stepping stones to jobs and a fulfilling life in a rapidly changing world.

References

- Blau, P. and Duncan, O. D. (1967) *The American Occupational Structure*. Wiley.
- Bright, M. (2001) *Welfare to work and the organisation of opportunity: Lessons from abroad*. CASE paper 15, Centre for Analysis of Social Exclusion.
- Bynner, J. and Parsons, S. (1997) *Does Numeracy Matter?* London: Basic Skills Agency.
- Bynner, J. and Parsons, S. (2006) *New Light on Literacy and Numeracy: Results of the Literacy and Numeracy Assessment in the Age 34 Follow-up of the 1970 Cohort Study (BCS70)*. London: NRDC.
- Bynner, J. and Parsons, S. (2009) 'Insights into Basic Skills from a UK Longitudinal Study', in S. Reder and J. Bynner, J (eds) *Tracking Adult Literacy and Numeracy Skills: Findings from Longitudinal Research*. New York: Routledge.
- Bynner, J. and Steedman, J. (1995) *Difficulties with Basic Skills*. London: The Basic Skills Agency.
- Clark, P.M. (2008) *Technological Change and Lifelong Learning: Perfect Storm or Tornado?* Presentation to NIACE Expert Seminar on Life-Long Learning and Technological Change. Available at: www.niace.org.uk/lifelonglearninginquiry/docs/Paul-Clark-technology-evidence.pdf
- DfEE (1999) *A Fresh Start – Improving Literacy and Numeracy*. London: Department for Education and Employment.
- DfEE (2001) *Skills for Life: The national strategy for improving adult literacy and numeracy skills*. DfEE publication, report ref: SFLLN. London: Department for Education and Employment.
- DIUS (2009) *Skills for Life: Changing Lives*. London: Department for Innovation, Universities and Skills. Available at: www.dius.gov.uk/~media/publications/S/SkillsforLifeChangingLives (accessed 14 July 2009).
- Dugdale, G. and Clark, C. (2008) *literacy Changes Lives: An advocacy resource*. National Literacy Trust.
- Howard, H. (2000) 'Learning with IT: Towards a Research Agenda – Questions and Issues', *Journal of the Association of Learning Technologies*, 8 (3) pp. 31–40.
- Kirsch, I., Yamamoto, K., Norris, N., Rock, D., Jungeblut, A., O'Reilly, P., Campbell, A., Jenkins, L., Kolstad, A., Berlin, M., Mohadjer, L., Waksberg, J., Goksel, H., Burke, J., Rieger, S., Green, J., Klein, M., Mosenthal, P. and Baldi,

S. (2000) *Technical Report and Data File Users Manual for the 1992 National Adult Literacy Survey*. National Center for Education Statistics publication # 2001457. Available at:
<http://nces.ed.gov/pubsearch/pubsinfo.asp?pubid=2001457>

Kline, R. B. (1998) *Principles and Practice of Structural Equation Modeling*. New York, London: The Guildford Press.

Levy, F. and Murnane, R.J. (2004) *The New Division of Labor: How Computers are Creating the Next Job Market*. Princeton and Oxford: Princeton University Press.

Maruyama, G. M. (1998). *Basics of Structural Equation Modeling*. Thousand Oaks, CA: Sage Publications.

McNair, S. (2009) *Demography and Lifelong Learning: IFLL Thematic Paper 1*. Leicester: NIACE. Available at:
www.niace.org.uk/lifelonglearninginquiry/docs/Demography-Lifelong-Learning.pdf
(accessed 16 July 2009).

Mellar, H., Kambouri, M., Sanderson, M. and Pavlou, V. (2004) *ICT and Adult Literacy, Numeracy and ESOL*. London: NRDC.

NIACE (2008) *ICT as a Skill for Life*, draft strategy paper for NIACE consultation on life-long learning. Available at <http://archive.niace.org.uk/Research/ICT/ICT-Skill-for-Life-summary.pdf> (accessed 14 July 2009).

OECD (1997) *Literacy Skills for the Knowledge Society: Further Results from the International Adult Literacy Survey*. Paris: Organization for Economic Cooperation and Development (OECD).

OECD (2000) *Literacy in the Information Age: Final Report of The International Adult Literacy Survey*. OECD.

Parsons, S. and Bynner, J. (2006) *Does Numeracy Matter More?* London: NRDC.

Parsons, S. and Bynner, J. (2007) *Illuminating Disadvantage: Profiling the experiences of adults with Entry Level Literacy or Numeracy over the life course*. London: NRDC.

Reder, S. (2008) 'The Development of Literacy and Numeracy in Adult Life', in S. Reder and J. Bynner (eds.) *Tracking Adult Literacy and Numeracy Skills: Findings from Longitudinal Research*. New York: Routledge.

Reder, S. (2009) 'The Development of Literacy and Numeracy in Adult Life' in S. Reder, and J. Bynner, J. (eds) *Tracking Adult Literacy and Numeracy Skills: Findings from Longitudinal Research*, p 27–58. New York: Routledge.

Snow, C.E. and Strucker, J. (2000) 'Lessons from Preventing Reading Difficulties in Young Children for Adult Learning and Literacy', in J. Comings, B. Garner and C. Smith (eds) *Annual Review of Adult Learning and Literacy*, vol.1, pp. 25–73. San Francisco: Jossey Bass.

Strawn, C. (2008) *The Relationship between Literacy Proficiency and the Digital Divide*, Technical Report, Dept. Applied Linguistics, Portland State University
www.lsal.edu/littech.pdf

Sum, A., Kirsch, J. and Yamamoto, K. (2004) *Pathways to Labor Market Success: The Literacy Proficiency of U.S. Adults*. Princeton, NJ: Policy Information Centre, Educational Testing Service.

Williams, J., Clemens, S., Oleinikova, K. and Tarvin, K. (2003) *The Skills for Life survey: A national needs and impact survey of literacy, numeracy and ICT skills*. DfES Research Report 490. Department for Education and Skills.

Appendix 1: London and Portland longitudinal study details

1970 British Cohort Study (BCS70) www.cls.ioe.ac.uk

The study

The 1970 British Cohort Study (BCS70) is a continuing, multi-disciplinary longitudinal study which takes as its subjects all those living in England, Scotland and Wales who were born in one particular week in April 1970.

BCS70 began when data were collected about the births and families of just under 17,200 babies born in England, Scotland, Wales and Northern Ireland in a particular week in April 1970. At this time, the study was named the British Births Survey (BBS), and it was sponsored by the National Birthday Trust Fund in association with the Royal College of Obstetricians and Gynaecologists. Since 1970 there have been six attempts to gather information from the whole cohort. The Centre for Longitudinal Studies is now the custodian of BCS70. In 2004, the latest wave of data collection, 9665 cohort members were interviewed. Information collected

With each successive attempt, the scope of enquiry has broadened from a strictly medical focus at birth, to encompass physical and educational development at the age of 5, physical, educational and social development at the ages of 10 and 16, and then to include economic development, family life and other wider factors such as personal well-being and community participation at 26, 30 and 34. Data have been collected from a number of different sources, e.g. parents, teachers, health visitors, nurses and and in a variety of ways. This includes paper-based and computer-assisted interviews and self-completion questionnaires, physical assessments and cognitive tests.

At age 34 all participating cohort members had their literacy, numeracy and symptoms associated with dyslexia assessed. For further details see Parsons and Bynner (2006) 'Measuring Basic Skills for Longitudinal Study' *Literacy and Numeracy Studies*, Volume 14, No. 2, p7–30.

Relevant publications (see CLS website for full list of available publications using BCS70 data)

Bynner, J. and Parsons, S. (2006) *New Light on Literacy and Numeracy: Results of the literacy and numeracy assessment in the age 34 follow-up of the 1970 British Cohort Study (BCS70)*. London: NRDC.

Bynner, J. and Parsons, S. (2002) 'Social Exclusion and the Transition from School to Work: The Case of Young People Not in Education, Employment or Training', *Journal of Vocational Behavior*, vol. 60, p. 289–309.

Bynner, J. and Parsons, S. (2001) 'Qualifications, Basic Skills and Accelerating Social Exclusion', *Journal of Education and Work*, vol. 14, no. 3, p. 279–291.

Parsons, S. and Bynner, J. (2007) *Illuminating Disadvantage: Profiling the experiences of adults with Entry level literacy or numeracy over the lifecourse*. London: NRDC.

Longitudinal Study of Adult Learning (SAL) www.lsal.pdx.edu

The study

The findings of the longitudinal study will represent adults who in 1998 when the study started were age 18–44, residents of the Portland (Oregon) metropolitan area, proficient but not necessarily native speakers of English, who did not have a high school diploma or GED and were not in high school. This is a target population for local Adult Basic and Adult Secondary Education programmes. To better understand the contribution of adult literacy programmes to the learning and literacy development of adults, LSAL compares the experiences of adults who participate and do not participate in the formal programmes. People entering an Adult Basic Education (ABE) Programme in 1998 at one of several area community colleges were recruited into the study selection pool as a way to over-sample students for adequate statistical comparison.

Information collected

An extensive background survey instrument collects information on learning in multiple contexts: formal education programmes include ABE, work contexts, home and family, and personal interests. Additional one time modules have been added on, including learning disabilities, turbulence in daily life, health and computer literacy.

All participants in the study also have their literacy assessed at each wave of interviewing with TALS Document Literacy assessment. For further details see: <http://nces.ed.gov/pubsearch/pubsinfo.asp?pubid=2001457>. Other oral and written assessments have also been used at different waves of data collection.

Participants were also asked if administrative data could be used. These data are available from the Oregon state agencies through special arrangement for educational research. They include community college participation (<http://www.odccwd.state.or.us/>), GED test taking and certification, and unemployment insurance (UI) hours and wages. Approximately 80 per cent of the sample gave the research team permission to use their social security numbers to match these databases.

Publications available on LSAL website

Reder, S. and Strawn, S. (2006) 'Self-Study: Broadening the Concepts of Participation and Program Support', *Focus on Basics*, vol. 8, issue C, November 2006. http://www.ncsall.net/fileadmin/resources/fob/2006/fob_8c.pdf

Reder, S. and Strawn, S. (2001) 'The K–12 School Experiences of High School Dropouts', *Focus on Basics*, vol. 4, issue D, April 2001.

<http://ncsall.gse.harvard.edu/fob/2001/reder.html>

Reder, S. and Strawn, S. (2001) 'Program Participation and Self-Directed Learning to Improve Basic Skills', *Focus on Basics*, vol. 4, issue D, April 2001.

<http://ncsall.gse.harvard.edu/fob/2001/reder2.html>

Reder, S. (2007) *Giving Literacy Away, Again*. <http://www.lsal.pdx.edu/./RederRISEwithfigstablesfinal.pdf>

Published in A. Belzer (2007) *Toward Defining and Improving Quality in Adult Basic Education: Issues and Challenges*. Mahwah, NJ: Erlbaum

Secombe, K., Lockwood, R.S. and Reder, S. (2005) *Literacy: Influence on Access and use of the Health Care System*.

http://www.lsal.pdx.edu/./secombe_lockwood_reder.pdf Published in J.J. Kronenfeld (ed.) (2005) *Health Care Services, Racial and Ethnic Minorities and Underserved Populations: Patient and Provider Perspectives*. Elsevier.

Strawn, C. (2003) 'The Influences of Social Capital on Lifelong Learning Among Adults Who Did Not Finish High School. Portland, Oregon: Portland State University/NCSALL.

http://www.lsal.pdx.edu/downloads/op_strawn.pdf

Appendix 2: SEM statistics

Table A1a: LSAL estimates for Portland and Comparative Model (fully saturated results)

	Portland and Comparative Model					
	Portland (A)		Portland (B)		Comparative	
	Std estimate	s.e.	Std estimate	s.e.	Std estimate	s.e.
LITERACY						
Computer use	0.15	0.07	0.22	0.08	0.17	0.08
Literacy	0.60	0.12	0.57	0.12		
Time spent employed	0.21	0.10	0.21	0.08	0.43	0.10
Parents education	-0.07	0.10	-0.09	0.09	0.09	0.11
Gender	0.06	0.07	0.03	0.06	0.15	0.10
Ethnicity	0.16	0.10	0.23	0.10	0.21	0.10
Number of children	0.01	0.06	-0.05	0.07	0.12	0.08
COMPUTER USE						
Computer use	0.35	0.11	0.14	0.12	0.35	0.11
Literacy	0.02	0.09	0.14	0.07		
Time spent employed	0.11	0.13	0.18	0.11	0.11	0.12
Parents education	-0.03	0.07	0.15	0.14	-0.02	0.08
Gender	0.07	0.09	0.04	0.13	0.07	0.11
Ethnicity	- .03	0.10	-0.01	0.09	-0.03	0.09
Number of children	0.04	0.09	0.04	0.13	0.04	0.08
TIME SPENT EMPLOYED						
Computer use	0.14	0.09	-0.13	0.13	0.15	0.09
Literacy	0.10	0.10	0.13	0.08		
Time spent employed	0.42	0.11	0.47	0.09	0.45	0.10
Parents education	-0.05	0.10	-0.05	0.10	-0.03	0.09
Gender	-0.11	0.11	-0.12	0.11	-0.10	0.10
Ethnicity	0.14	0.10	0.11	0.09	0.15	0.11
Number of children	0.24	0.09	0.23	0.10	0.26	0.09
Correlations at Time 2						
Literacy and Computer use	0.12	0.06	-0.10	0.10	0.10	0.09
Literacy and Time spent employed	0.06	0.08	0.16	0.10	0.12	0.14
Computer use and Time spent employed	0.37	0.12	0.06	0.09	0.37	0.09
R-square						
Literacy	0.56	0.10	0.58	0.10	0.32	0.08
Computer use	0.15	0.06	0.14	0.06	0.15	0.06
Time spent employed	0.40	0.08	0.39	0.09	0.39	0.08
<i>n</i>	200		200		200	

Bold = significance < .10 s.e. = standard error

Table A1b: LSAL estimates for Portland Model A (fully saturated and constrained results)

	Saturated		Constrained	
	Std estimate	s.e.	Std estimate	s.e.
LITERACY				
Computer use	0.15	0.07	0.16	0.07
Literacy	0.60	0.12	0.61	0.12
Time spent employed	0.21	0.10	0.20	0.10
Parents education	-0.07	0.10	-0.07	0.10
Gender	0.06	0.07	0.06	0.07
Ethnicity	0.16	0.10	0.16	0.10
Number of children	0.01	0.06	0.01	0.06
COMPUTER USE				
Computer use	0.35	0.11	0.32	0.09
Literacy	0.02	0.09		
Time spent employed	0.11	0.13		
Parents education	-0.03	0.07	-0.07	0.10
Gender	0.07	0.09	0.06	0.07
Ethnicity	- .03	0.10	0.16	0.10
Number of children	0.04	0.09	0.01	0.06
TIME SPENT EMPLOYED				
Computer use	0.14	0.09		
Literacy	0.10	0.10		
Time spent employed	0.42	0.11	0.46	0.10
Parents education	-0.05	0.10	-0.01	0.09
Gender	-0.11	0.11	-0.12	0.12
Ethnicity	0.14	0.10	0.15	0.10
Number of children	0.24	0.09	0.24	0.09
Correlations at Time 2				
Literacy and Computer use	0.12	0.06	0.10	0.05
Literacy and Time spent employed	0.06	0.08		
Computer use and Time spent employed	0.37	0.12	0.37	0.09
R-Square				
Literacy	0.56	0.10	0.56	0.10
Computer use	0.15	0.06	0.10	0.06
Time spent employed	0.40	0.08	0.35	0.09
<i>n</i>		200		200

bold = significance < .10 s.e. = standard error

Table A2: BCS70 estimates for Comparative and Elaborated London Model (fully saturated results)

	Comparative and Elaborated London Model					
	Overall		Men		Women	
	Std estimate	s.e.	Std estimate	s.e.	Std estimate	s.e.
LITERACY						
Computer use	0.20	0.03	0.17	0.04	0.19	0.05
Time spent employed	0.11	0.07	0.18	0.11	0.08	0.08
Parents education	-0.13	0.14	0.06	0.02	-0.02	0.18
Gender	0.10	0.06				
Number of children	-0.07	0.06	-0.10	0.09	-0.04	0.07
COMPUTER USE						
Computer use	0.56	0.05	0.72	0.06	0.41	0.08
Time spent employed	0.10	0.04	0.03	0.05	0.18	0.06
Parents education	-0.01	0.03	-0.06	0.07	0.00	0.02
Gender	0.04	0.05				
Number of children	-0.03	0.05	-0.04	0.05	-0.04	0.07
TIME SPENT EMPLOYED						
Computer use	0.01	0.04	-0.08	0.06	0.06	0.06
Time spent employed	0.55	0.06	0.66	0.10	0.52	0.07
Parents education	-0.04	0.04	0.04	0.02	-0.07	0.05
Gender	-0.17	0.05				
Number of children	0.03	0.05	-0.03	0.08	0.07	0.08
Correlations at Time 2						
Literacy and Computer use	0.14	0.03	0.13	0.04	0.16	0.05
Literacy and Time spent employed	0.08	0.06	-0.01	0.08	0.11	0.08
Computer use and Time spent employed	0.26	0.05	0.12	0.07	0.35	0.06
R-Square						
Literacy	0.09	0.04	0.09	0.04	0.18	0.12
Computer use	0.36	0.06	0.51	0.08	0.28	0.07
Time spent employed	0.39	0.05	0.43	0.13	0.28	0.06
<i>n</i>		356		165		191

Bold = significance < .10

s.e. = standard error

Table A3: BCS70 estimates for Elaborated London Model including occupation status (fully saturated results)

	Elaborated London Model					
	Overall		Men		Women	
	Std estimate	s.e.	Std estimate	s.e.	Std estimate	s.e.
LITERACY						
Computer use	0.15	0.04	0.14	0.05	0.18	0.05
Occupation status	0.13	0.06	0.15	0.08	0.16	0.11
Parents education	0.05	0.02	0.05	0.02	0.06	0.07
Gender	0.07	0.06				
Number of children	-0.10	0.08	-0.16	0.10	0.02	0.13
COMPUTER USE						
Computer use	0.55	0.06	0.68	0.07	0.39	0.09
Occupation status	0.21	0.05	0.16	0.06	0.30	0.10
Parents education	-0.05	0.05	0.09	0.08	0.03	0.09
Gender	0.12	0.05				
Number of children	-0.07	0.04	-0.05	0.05	-0.08	0.09
OCCUPATION STATUS						
Computer use	0.21	0.05	0.26	0.07	0.16	0.08
Occupation status	0.55	0.06	0.53	0.08	0.48	0.11
Parents education	0.02	0.02	0.01	0.02	0.14	0.10
Gender	0.03	0.05				
Number of children	-0.03	0.05	-0.04	0.06	-0.15	0.10
Correlations at Time 2						
Literacy and Computer use	0.16	0.04	0.12	0.02	0.24	0.06
Literacy and Occupation status	0.08	0.04	0.08	0.06	0.11	0.06
Computer use and Occupation status	0.26	0.07	0.23	0.09	0.27	0.10
R-Square						
Literacy	0.09	0.03	0.09	0.04	0.09	0.04
Computer use	0.49	0.05	0.56	0.07	0.41	0.08
Occupation status	0.46	0.06	0.47	0.08	0.48	0.08
<i>n</i>	232		137		95	

Bold = significance < .10 s.e. = standard error